

AN AMERICAN NATIONAL STANDARD

ASME  
PTC 30-1991

# Air Cooled Heat Exchangers



PERFORMANCE  
TEST  
CODES

THE AMERICAN SOCIETY OF MECHANICAL ENGINEERS  
United Engineering Center  
345 East 47th Street New York, N.Y. 10017

ASMENORMDOC.COM : Click to view the full PDF of ASME PTC 30 1991

INTENTIONALLY LEFT BLANK

ASMENORMDOC.COM : Click to view the full PDF of ASME PTC 30 1997

# Air Cooled Heat Exchangers

PERFORMANCE  
TEST  
CODES

ASME PTC 30-1991

AN AMERICAN NATIONAL STANDARD

THE AMERICAN SOCIETY OF MECHANICAL ENGINEERS

United Engineering Center

345 East 47th Street

New York, N.Y. 10017

ASMENORMDOC.COM : Click to view the full PDF of ASME PTC 30-1991

Date of Issuance: May 30, 1991

The 1991 edition of this document is being issued with an automatic addenda subscription service. The use of an addenda allows revisions made in response to public review comments or committee actions to be published as necessary; revisions published in addenda will become effective 1 year after the Date of Issuance of the document. This document will be revised when the Society approves the issuance of the next edition, scheduled for 1996.

ASME issues written replies to inquiries concerning interpretation of technical aspects of this document. The interpretations will be included with the above addenda service. Interpretations are not part of the addenda to the document.

ASME is the registered trademark of The American Society of Mechanical Engineers

This code or standard was developed under procedures accredited as meeting the criteria for American National Standards. The Consensus Committee that approved the code or standard was balanced to assure that individuals from competent and concerned interests have had an opportunity to participate. The proposed code or standard was made available for public review and comment which provides an opportunity for additional public input from industry, academia, regulatory agencies, and the public-at-large.

ASME does not "approve," "rate," or "endorse" any item, construction, proprietary device, or activity.

ASME does not take any position with respect to the validity of any patent rights asserted in connection with any items mentioned in this document, and does not undertake to insure anyone utilizing a standard against liability for infringement of any applicable Letters Patent, nor assume any such liability. Users of a code or standard are expressly advised that determination of the validity of any such patent rights, and the risk of infringement of such rights, is entirely their own responsibility.

Participation by federal agency representative(s) or person(s) affiliated with industry is not to be interpreted as government or industry endorsement of this code or standard.

ASME accepts responsibility for only those interpretations issued in accordance with governing ASME procedures and policies which preclude the issuance of interpretations by individual volunteers.

No part of this document may be reproduced in any form,  
in an electronic retrieval system or otherwise,  
without the prior written permission of the publisher.

Copyright © 1991 by  
THE AMERICAN SOCIETY OF MECHANICAL ENGINEERS  
All Rights Reserved  
Printed in U.S.A.

## FOREWORD

(This Foreword is not part of ASME PTC 30-1991.)

In May 1960 the Board on Performance Test Codes organized PTC 30 on Atmospheric Cooling Equipment to provide uniform methods and procedures for testing air cooled heat exchangers, and the means for interpreting the test results to enable reliable evaluation of the performance capability of the equipment. This Committee was chaired by Mr. R. T. Mathews, and under his guidance a preliminary Draft of PTC 30 for Air Cooled Heat Exchangers was developed. Following the death of Chairman Mathews the Board on Performance Test Codes directed the reorganization of this Committee in 1977 under the leadership of interim Chairman Mr. J. C. Westcott. The newly reorganized committee was entitled PTC 30 on Air Cooled Heat Exchangers. On April 20, 1977 Mr. J. C. Westcott relinquished the Chair and Mr. J. C. Campbell was elected Chairman.

This Code was approved by the PTC 30 Committee on May 22, 1990. It was approved by the ASME Board on Performance Test Codes and adopted as a standard practice of the Society on October 5, 1990. It was approved as an American National Standard on February 15, 1991, by the Board of Standards Review of the American National Standards Institute.

All ASME codes are copyrighted, with all rights reserved to the Society. Reproduction of this or any other ASME code is a violation of Federal Law. Legalities aside, the user should appreciate that the publishing of the high quality codes that have typified ASME documents requires a substantial commitment by the Society. Thousands of volunteers work diligently to develop these codes. They participate on their own or with a sponsor's assistance and produce documents that meet the requirements of an ASME consensus standard. The codes are very valuable pieces of literature to industry and commerce, and the effort to improve these "living documents" and develop additional needed codes must be continued. The monies spent for research and further code development, administrative staff support and publication are essential and constitute a substantial drain on ASME. The purchase price of these documents helps offset these costs. User reproduction undermines this system and represents an added financial drain on ASME. When extra copies are needed, you are requested to call or write the ASME Order Department, 22 Law Drive, Box 2300, Fairfield, New Jersey 07007-2300, and ASME will expedite delivery of such copies to you by return mail. Please instruct your people to buy required test codes rather than copy them. Your cooperation in this matter is greatly appreciated.

ASMENORMDOC.COM : Click to view the full document

**PERSONNEL OF ASME PERFORMANCE TEST CODE COMMITTEE NO. 30  
ON AIR COOLED HEAT EXCHANGERS**

(The following is the roster of the Committee at the time of approval of this Standard.)

**OFFICERS**

**J. C. Campbell, *Chairman***  
**R. B. Miller, *Vice Chairman***  
**J. Karian, *Secretary***

**COMMITTEE PERSONNEL**

**J. A. Bartz, Edison Power Research Institute**  
**K. J. Bell, Oklahoma State University**  
**J. M. Burns, Stone and Webster Engineering Corp.**  
**J. C. Campbell, Lillie-Hoffman Cooling Towers, Inc. (retired)**  
**R. R. Carpenter, Duke Power Co.**  
**M. C. Hu, United Engineers and Constructors, Inc.**  
**B. M. Johnson, Battelle Northwest**  
**G. E. Kluppel, Hudson Products Corp.**  
**P. A. Lindahl, The Marley Cooling Tower Co.**  
**P. M. McHale, Ebasco Plant Services Inc.**  
**R. B. Miller, Stone and Webster Engineering Corp.**  
**D. S. Parris, Jr., American Energy**  
**J. G. Yost, Environmental Systems Corp.**

**BOARD ON PERFORMANCE TEST CODES PERSONNEL**

J. S. Davis, Jr., *Vice President*  
N. R. Deming, *Vice Chairman*  
W. O. Hays, *Secretary*

A. F. Armor  
R. L. Bannister  
R. J. Biese  
J. A. Booth  
B. Bornstein  
H. G. Crim  
G. J. Gerber

P. M. Gerhart  
R. Jorgensen  
D. R. Keyser  
W. G. McLean  
G. H. Mittendorf, Jr.  
J. W. Murdock  
S. P. Nuspl

R. P. Perkins  
R. W. Perry  
A. L. Plumley  
C. B. Scharp  
J. W. Siegmund  
R. E. Sommerlad  
J. C. Westcott

ASMENORMDOC.COM : Click to view the full PDF of ASME PTC 30 1997



# CONTENTS

Foreword .....	iii
Committee Roster .....	v
<b>0 Introduction .....</b>	<b>1</b>
<b>1 Object and Scope .....</b>	<b>3</b>
1.1 Object .....	3
1.2 Scope .....	3
1.3 Uncertainty .....	3
<b>2 Definitions and Description of Terms .....</b>	<b>5</b>
2.1 Terms .....	5
2.2 Letter Symbols .....	8
<b>3 Guiding Principles .....</b>	<b>11</b>
3.1 General .....	11
3.2 Agreements Prior to Test .....	11
3.3 Selection of Personnel .....	11
3.4 Pre-Test Uncertainty Analysis .....	11
3.5 Arrangement of Test Apparatus .....	11
3.6 Methods of Operation During Testing .....	12
3.7 Provisions for Equipment Inspection .....	12
3.8 Calibration of Instruments .....	12
3.9 Preliminary Testing .....	12
3.10 Conduct of Test .....	13
3.11 Permissible and Nonpermissible Adjustments to Test Procedures .....	13
3.12 Duration of Test .....	13
3.13 Number of Test Readings .....	13
3.14 Permissible Limits of Test Parameters .....	13
3.15 Degree of Constancy of Test Conditions .....	14
3.16 Causes for Rejection of Test Readings or Results .....	14
3.17 Post-Test Uncertainty Analysis .....	14
<b>4 Instruments and Methods of Measurement .....</b>	<b>15</b>
4.1 General .....	15
4.2 Measurement of Physical Dimensions .....	15
4.3 Fan Measurements .....	15
4.4 Measurement of Air Flow .....	15
4.5 Measurement of Air-Side Pressure Differential .....	17
4.6 Measurement of Fan Driver Power .....	18

4.7	Measurement of Sound Level .....	19
4.8	Measurement of Atmospheric Pressure .....	19
4.9	Measurement of Environmental Effects .....	19
4.10	Measurement of Wind Velocity .....	19
4.11	Measurement of Air Temperatures .....	19
4.12	Measurement of Ambient and Entering Air Temperatures .....	20
4.13	Measurement of Exit Air Temperature .....	20
4.14	Measurement of Process Fluid Temperatures .....	20
4.15	Measurement of Process Fluid Pressures .....	20
4.16	Measurement of Process Fluid Flow Rate .....	21
4.17	Measurement of Composition of Process Fluid .....	21
<b>5</b>	<b>Computation of Results .....</b>	<b>23</b>
5.1	General .....	23
5.2	Review of Test Data and Test Conditions .....	23
5.3	Reduction of Test Data .....	23
5.4	Determination of Material and Heat Balances .....	24
5.5	Computation of Effective Mean Temperature Difference .....	25
5.6	Computation of Overall Heat Transfer Coefficient .....	25
5.7	Determination of Air-Side Pressure Losses .....	26
5.8	Determination of Process Fluid Pressure Losses .....	26
5.9	Adjustments of Test Data to Design Conditions .....	28
<b>6</b>	<b>Report of Results .....</b>	<b>47</b>
6.1	Composition of Report .....	47
6.2	Report Data .....	48

## Figures

4.1	Location of Air Velocity and Temperature Measurement Points Across Fan Ring .....	16
4.2	Typical Velocity Distribution Across Fan Stack .....	18
5.1	Mean Temperature Difference Relationships – Crossflow Unit – 1 Tube Row, Unmixed .....	33
5.2	Mean Temperature Difference Relationships – Crossflow Unit – 2 Tube Rows, 1 Pass, Unmixed .....	34
5.3	Mean Temperature Difference Relationships – Crossflow Unit – 3 Tube Rows, 1 Pass, Unmixed .....	35
5.4	Mean Temperature Difference Relationships – Crossflow Unit – 4 Tube Rows, 1 Pass, Unmixed .....	36
5.5	Mean Temperature Difference Relationships – Crossflow Unit – 2 Tube Rows, 2 Passes, Unmixed Between Passes .....	37
5.6	Mean Temperature Difference Relationships – Crossflow Unit – 3 Tube Rows, 3 Passes, Unmixed Between Passes .....	38
5.7	Mean Temperature Difference Relationships – Crossflow Unit – 4 Tube Rows, 4 Passes, Unmixed Between Passes .....	39
5.8	Mean Temperature Difference Relationships – Crossflow Unit – 4 Tube Rows in 2 Passes, 2 Tube Rows per Pass, Mixed at the Header .....	40
5.9	Schematic of Process Fluid Piping .....	41
5.10	Fin Efficiency of Several Types of Straight Fins .....	42
5.11	Efficiency Curves for Four Types of Spine Fins .....	43
5.12	Efficiency of Annular Fins of Constant Thickness .....	44
5.13	Efficiency of Annular Fins With Constant Metal Area for Heat Flow .....	45

**Tables**

4.1 Recommended Minimum Number of Air Velocity  
Measurement Points for Fan Ring Traverse ..... 17

5.1 Values of  $F_{tr}$  for Equation 5.38 ..... 31

**Appendices**

A Testing Guidelines ..... 49

B Example ..... 51

C Example Uncertainty Analysis ..... 57

D Special Considerations for Computation and Adjustment of  
Results ..... 65

E Fouling ..... 77

F Recirculation of Air ..... 79

G References ..... 81

**Figures**

D.1 Moody-Darcy Friction Factor Chart for Flow Through Plain  
Tubes ..... 66

D.2a Chart for Calculating In-Tube Heat Transfer Coefficients for  
Water ..... 69

D.2b Correction Factor to Fig. D.2a for Other Tube Diameters ..... 70

D.3 Two-Phase Flow Friction Pressure Drop Correction Factor ..... 72

D.4  $\beta$  as a Function for  $\psi_m$  for the Chaddock Method ..... 73

D.5 Colburn Correlation for Condensation on a Vertical Surface  
– No Vapor Shear ..... 74

**Tables**

C.1a Sensitivity Factors for Uncertainty Analysis ..... 60

C.1b Sensitivity Factors for Uncertainty Analysis ..... 61

C.2 Error Estimate Values for Capability ..... 62

C.3 Error Estimate Values for Capability ..... 63

C.4 Two-Tailed STUDENT  $t$  Table for the 95 Percent  
Confidence Level ..... 64

INTENTIONALLY LEFT BLANK

ASMENORMDOC.COM : Click to view the full PDF of ASME PTC 30 1997

# ASME PERFORMANCE TEST CODES

## Code on

# AIR COOLED HEAT EXCHANGERS

## SECTION 0 – INTRODUCTION

This Code provides instructions for the testing of air cooled heat exchangers. The equipment, as herein defined, refers to apparatus for the transfer of heat from process fluids to atmospheric air.

The testing methods described in this Code will yield results of accuracy consistent with current engineering knowledge and practice.

The purpose of this Code is to provide standard directions and rules for the conduct and report of performance tests on air cooled heat exchangers and the measurement and evaluation of relevant data.

This Code is a voluntary standard; adherence to it depends on prior mutual agreement of all parties involved in the performance testing of specific air cooled heat exchangers.

Unless otherwise specified, all references herein to other codes refer to ASME Performance Test Codes. Terms used but not defined herein are defined in the Code on Definitions and Values (PTC 2). Descriptions of instruments and apparatus, beyond those specified and described in this Code, but necessary to conduct the tests, may be found in the Supplements on Instruments and Apparatus (PTC 19 Series).

When using this Code, a careful study should first be made of the most recent issues of Codes on General Instructions (PTC 1), and Definitions and Values (PTC 2), together with all other codes referred to herein. In the event of any discrepancies between specific directions contained herein, and those in codes incorporated by reference, this Code shall govern.

INTENTIONALLY LEFT BLANK

ASMENORMDOC.COM : Click to view the full PDF of ASME PTC 30 1997

## SECTION 1 — OBJECT AND SCOPE

### 1.1 OBJECT

The object of this Code is to provide uniform methods and procedures for testing the thermodynamic and fluid mechanical performance of air cooled heat exchangers, and for calculating adjustments to the test results to design conditions for comparison with the guarantee as defined in para. 5.9.4.

Excluded from the scope of this Code are evaporative type coolers (wet cooling towers), and any cooling equipment which combines evaporative and convective air cooling (wet/dry type).

This Code does apply to wet/dry type heat exchangers when, by mutual agreement, the heat exchanger can be operated and tested as a dry type unit.

### 1.2 SCOPE

The scope of this Code covers, but is not limited to, the testing of *mechanical draft* heat exchangers, of both the *forced draft* and *induced draft* types; *natural draft* heat exchangers; and *fan assisted natural draft* heat exchangers.

From a heat transfer surface standpoint, this Code covers all tube bundle orientations, including: *vertical*, *horizontal*, and *slanted conduit* heat exchangers.

Both *bare surfaces* and *finned surfaces* are included as conduit type heat exchanger components. While conventional round tubes with circular fins are assumed in this Code, the procedures can be modified by mutual agreement to apply to other surface configurations.

While the cooling fluid is restricted to atmospheric air, the tube-side fluid can be any chemical element, compound or mixture, in single-phase flow, liquid or gas, or in two-phase flow.

This Code is written under the assumption that the Air Cooled Heat Exchanger (ACHE) may be tested as having a discrete process stream or that only one process fluid stream is being investigated. In other cases, modifications must be made to the procedures

presented. Such modifications shall be agreed by the parties to the test.

The scope of this Code also includes, directly or by reference, recommended methods for obtaining data, measurements, observations, and samples to determine the following:

- (a) Physical Dimensions
- (b) Air Flow Rate
- (c) Air-Side Pressure Differential
- (d) Fan Driver Power
- (e) Sound Level
- (f) Atmospheric Pressure
- (g) Environmental Effects
- (h) Wind Velocity
- (i) Air Temperatures
  - (j) Entering Air Temperature
  - (k) Exit Air Temperature
- (l) Process Fluid Temperatures
- (m) Process Fluid Pressures
- (n) Process Fluid Flow Rate
- (o) Composition of Process Fluid
- (p) Percent Capability
- (q) Process Fluid Pressure Drop

### 1.3 UNCERTAINTY

In keeping with the philosophy of the Code, the best available technical information has been used in developing the recommended instrumentation and procedures to provide the highest level of testing accuracy. Every measurement has some uncertainty; therefore, so do the test results. Any departure from Code recommendations could introduce additional uncertainty in the measurements beyond that considered acceptable to meet the objectives of a Code test. The expected uncertainty level(s) of tests run in accordance with this Code, based on estimates of precision and bias errors of the specified instrumentation and procedures, is  $\pm$  two to five percent.

Users of the Code shall determine the quality of a Code test for the specified equipment being tested

by performing pre-test and post-test uncertainty analyses. If either of these indicates uncertainty exceeding  $\pm$  five percent, the test shall not be deemed a Code test.

An example of the magnitude of the uncertainty in individual measurements and the manner in which individual uncertainties are combined to obtain overall test uncertainty of final results is included in Appendix C for a typical jacket-water cooler.

Test results shall be reported as calculated from test observations, with only such corrections as are provided in this Code. Uncertainties are not to be used to alter test results.

The Supplement on Measurement Uncertainty (PTC 19.1) provides additional information on combining types of errors into an overall test uncertainty.

ASMENORMDOC.COM : Click to view the full PDF of ASME PTC 30 1991



## SECTION 2 – DEFINITIONS AND DESCRIPTION OF TERMS

### 2.1 TERMS

In this Section only those terms are defined which are characteristic of air cooled heat exchangers and the requirements for testing them. For the definition of all other physical terms, or the description of instruments used in this Code, reference is made to the literature and to PTC 19 Series on Instruments and Apparatus.

Term	Description
Adjusted Value	A value adjusted from test conditions to design conditions.
Air	Mixture of gases and associated water vapor around the earth; dry air plus its associated water vapor. This term is used synonymously with <i>atmosphere</i> or <i>moist air</i> .
Air Cooled Heat Exchanger (ACHE)	A heat exchanger utilizing air as the heat sink to absorb heat from a closed circuit process fluid. This term is used synonymously with <i>dry cooling tower</i> in the power industry.
Air, Dry	Reference to the dry gas portion of air.
Air Flow Rate	The mass per unit time of air flowing through the ACHE.
Air, Standard	Dry air at standard temperature (70° F) and pressure (14.696 psia) which has a density of approximately 0.075 lbm/ft <sup>3</sup> .
Alternate Process Fluid	A fluid selected for use in performance testing when use of the actual design fluid is impractical for testing purposes due to proprietary or other reasons.
Ambient Air Temperature	The temperature of the air measured upwind of the ACHE within its air supply stream.
Ambient Wind Velocity	The speed and direction of the wind measured upwind of the ACHE within its air supply stream.
Approach Temperature Difference	The minimum temperature difference between the process stream and air stream at an exiting condition: (a) $T_2 - t_1$ (counterflow) or, (b) $T_1 - t_2$ (counterflow) or, (c) $T_2 - t_2$ (cocurrent flow or cross flow)

Term	Description
Aspect Ratio	The ratio of certain key dimensions that establishes similarity of shape or proportionality
Atmospheric Pressure	The pressure of the atmosphere at the location of the ACHE.
Bare Surface	The surface area of the bare conduit excluding extended surface. This term is used synonymously with <i>prime surface</i> .
Bay	One or more tube bundles served by one or more fans complete with structure, plenum, and other attendant equipment. This term is used synonymously with <i>cell</i> .
Bundle	Assembly of headers, tubes (conduits), tube supports and side frames.
Calibration	Establishment of a correction basis for an instrument by comparison to an acceptable reference standard. (See PTC 19 Series).
Capability	Thermal performance capability expressed in terms of test capacity, that is, the actual quantity of process fluid the ACHE will handle at design conditions of fluid inlet and outlet temperatures, fluid inlet pressure, fluid composition, air inlet temperature and fan power.
Design Values	Performance conditions upon which the design of the ACHE was guaranteed.
Drive Train Mechanical Efficiency	The fraction of the driver output power which is transmitted to the fan.
Entering Air Temperature	The temperature of the air entering the ACHE.
Exit Air Temperature	The temperature of the air leaving the ACHE.
Extended Surface	Surface area added to the bare surface.
Face Area	The gross air flow area through the ACHE heat transfer surface in a plane normal to the air flow.
Fan Assisted Natural Draft	A type of ACHE utilizing a combination of chimney effect and fan(s) to provide the required air flow.
Fan Input Power	The power which is actually transmitted to the fan.
Fan Pitch	The angle from the fan plane at the designated pitch measurement location to which the blades of a fan are set.
Fan Speed	The number of fan revolutions per unit time.
Fin Efficiency	The ratio of the total heat dissipated by the fin to that which would be dissipated if the entire fin surface were at the temperature of the fin root.
Finned Surface, Inside	The contact surface exposed to the process fluid. This term is used synonymously with <i>inside extended surface</i> .
Finned Surface, Outside	The contact surface exposed to the air flow. This term is used synonymously with <i>outside extended surface</i> .
Flow Regime	A fluid mechanics definition of flow characteristics, e.g., <i>laminar</i> or <i>turbulent</i> flow.

Term	Description
Forced Draft	A type of mechanical draft ACHE in which the fan is located in the air current upstream from the heat exchanger surface.
Fouling	Accumulated foreign material such as corrosion products or any other deposits on the heat transfer surface.
Free Flow Area	The minimum air flow area through the ACHE heat transfer surface in a plane normal to the air flow.
Induced Draft	A type of mechanical draft ACHE in which the fan is located in the air current downstream from the heat exchanger surface.
Initial Temperature Difference	Temperature difference between entering process temperature and entering air temperature, $T_1 - t_1$ .
Interference	Disturbance of the performance of an ACHE caused by an external heat source or obstruction.
Mechanical Draft	A type of ACHE in which the air flow is maintained by mechanical air moving devices such as fans or blowers.
Motor Output Power	The net power delivered by the motor output shaft.
Natural Draft	A type of ACHE in which the air flow is maintained by the difference in the densities of the ambient air and the exiting air streams.
Prime Surface	The surface area of the bare conduit excluding extended surface. This term is used synonymously with <i>bare surface</i> .
Process Fluid	The fluid circulated within the closed conduit of an ACHE.
Process Fluid Temperature	Generally, an average bulk temperature of the process fluid defined at some location entering, leaving, or within the ACHE.
Process Fluid Temperature Range	The difference between inlet and outlet temperatures of the process fluid.
Process Fluid Pressure Drop	The total hydraulic loss, including dynamic and static (if applicable) losses, between defined locations as the process fluid enters and leaves the ACHE.
Process Fluid Flow Rate	The mass per unit time of process fluid flowing through the ACHE.
Recirculation	The flow of exit air into the ACHE air inlet.
Test Run	A complete set of data that will allow analysis of capability per this Code. In some cases multiple test runs are taken and averaged to yield the capability.
Test Uncertainty	The overall uncertainty in results due to the combined effects of instrument inaccuracy, unsteady state conditions, and reading and methodological error.
Test Value	A value measured during a test with its calibration correction applied.
Tube Row	All of the tubes or conduits within an ACHE which have axial centerlines falling within a plane normal to the air flow. This term is synonymous to <i>tube layer</i> .
Unit	One or more tube bundles in one or more bays for an individual service.

## 2.2 LETTER SYMBOLS

Symbols that do not conform with this list will be defined in the text immediately following their usage. Numerical constants used in the equations and examples in the Code, unless otherwise specified, are based on U.S. Customary Units.

Symbol	Definition	Dimensions	
		U.S. Customary Units	SI Units
$A$	Heat transfer surface area	ft <sup>2</sup>	m <sup>2</sup>
ACFM	Actual cubic feet per minute	ft <sup>3</sup> /min	
$B$	Barometric pressure	in. Hg Abs.	Pa
BWG	Birmingham wire gage, a unit for measurement of thickness	Dimensionless	Dimensionless
$c_p$	Specific heat at constant pressure	Btu/lbm·°F	J/kg·°C
$c_v$	Specific heat at constant volume	Btu/lbm·°F	J/kg·°C
$d$	Wall thickness	ft	m
$D$	Diameter	ft	m
$D_e$	Equivalent diameter, $4S_o/Z_o$ and $4S_i/Z_i$	ft	m
DBT	Dry-bulb temperature	°F	°C
$E$	Elevation above mean sea level	ft	m
EMTD	Effective mean temperature difference	°F	°C
$F$	Temperature correction factor equal to EMTD/LMTD	Dimensionless	Dimensionless
$f_M$	Friction factor	Dimensionless	Dimensionless
$f_t$	Fin thickness	ft	m
$g$	Acceleration due to gravity	ft/sec <sup>2</sup>	m/s <sup>2</sup>
$g_c$	Proportionality factor in Newton's 2nd Law	32.18 $\frac{\text{lbm}\cdot\text{ft}}{\text{lbf}\cdot\text{sec}^2}$	$\frac{1 \text{ kg}\cdot\text{m}}{\text{N}\cdot\text{s}^2}$
$G$	Mass velocity, $w/S_o$ and $W/S_i$	lbm/hr-ft <sup>2</sup>	kg/s·m <sup>2</sup>
$h$	Coefficient of heat transfer	Btu/hr-ft <sup>2</sup> ·°F	W/m <sup>2</sup> ·°C
hp	Fan driver output power	hp	W
$H$	Enthalpy	Btu/lbm	J/kg
$H_t$	Latent heat of vaporization of process fluid	Btu/lbm	J/kg
ITD	Initial temperature difference, $(T_1 - t_1)$	°F	°C
$k$	Thermal conductivity	Btu/hr-ft·°F	W/m·°C
$l$	Fin height	ft	m
$L$	Length	ft	m

Symbol	Definition	Dimensions	
		U.S. Customary Units	SI Units
LMTD	Log mean temperature difference	°F	°C
$N$	Number of tubes	Dimensionless	Dimensionless
$N$	Number of measurements	Dimensionless	Dimensionless
$N_m$	Number of fins per unit length	ft <sup>-1</sup>	m <sup>-1</sup>
$N_m$	Fan speed	RPM	rps
NTU	Number of transfer units	Dimensionless	Dimensionless
Nu	Nusselt number, $hD/k$	Dimensionless	Dimensionless
$p$	Air pressure	lbf/ft <sup>2</sup>	Pa
$P$	Thermal effectiveness, $(t_2 - t_1)/(T_1 - t_1)$	Dimensionless	Dimensionless
$P$	Process stream pressure	lbf/ft <sup>2</sup>	Pa
Pr	Prandtl number, $c_p \mu/k$	Dimensionless	Dimensionless
$Q$	Heat transfer rate	Btu/hr	W
$r$	Radius	ft	m
$R$	Temperature difference ratio equal to $(T_1 - T_2)/(t_2 - t_1)$	Dimensionless	Dimensionless
$R$	Thermal resistance	hr-ft <sup>2</sup> -°F/Btu	m <sup>2</sup> -°C/W
$R_h$	Hydraulic radius	ft	m
$R_g$	Gas constant of air	53.32 ft-lbf/lbm-°R	286.9 J/kg-K
Re	Reynolds number, $GD/\mu$	Dimensionless	Dimensionless
RPM	Rotational speed	Revolutions per minute	
$s$	Net clear distance between fins	ft	m
$S$	Cross sectional flow area	ft <sup>2</sup>	m <sup>2</sup>
SCFM	Standard cubic feet per minute measured at 70°F and 14.696 psia, dry air	ft <sup>3</sup> /min	
St	Stanton number, $h/c_p G = \frac{Nu}{RePr}$	Dimensionless	Dimensionless
$t$	Air temperature	°F	°C
$T$	Process fluid temperature	°F	°C
$T_q$	Torque	lbf-ft	N-m
$U$	Overall heat transfer coefficient	Btu/hr-ft <sup>2</sup> -°F	W/m <sup>2</sup> -°C
$V$	Speed	ft/min	m/s
$w$	Air flow rate	lbm/hr	kg/s

Symbol	Definition	Dimensions	
		U.S. Customary Units	SI Units
$W$	Process fluid flow rate	lbm/hr	kg/s
WBT	Wet-bulb temperature	°F	°C
$Z$	Flow area wetted perimeter	ft	m
$\Sigma$	Summation	Dimensionless	Dimensionless
$\rho$	Density	lbm/ft <sup>3</sup>	kg/m <sup>3</sup>
$\eta$	Efficiency	Dimensionless	Dimensionless
$\epsilon$	Thermal effectiveness	Dimensionless	Dimensionless
$\phi$	Fin efficiency	Dimensionless	Dimensionless
$\phi_{vt}$	Two phase flow multiplier	Dimensionless	Dimensionless
$\Delta$	Differential	Dimensionless	Dimensionless
$\mu$	Viscosity	lbm/hr-ft	kg/s-m

Subscript	Description
$a$	Air
$af$	Air film
$b$	Bond
$d$	Dirt
$d$	Dry
$e$	Electrical
$f$	Fouling
$fn$	Fin
$H$	Hydraulic
$i$	Inside
$l$	Liquid
$m$	Mechanical
$m$	Moist
$o$	Outside
$P$	Prime tube
$p$	Process
$R$	Absolute temperature
$R$	Fin root wall
$r$	Reference surface
$s$	Static
$T$	Total
$v$	Vapor
$V$	Velocity
$w$	Wall
$Z$	Zone
1	Inlet
2	Outlet

Superscript	Description
*	Design value
°	Test value
+	Adjusted value

## SECTION 3 — GUIDING PRINCIPLES

### 3.1 GENERAL

The performance of atmospheric cooling equipment is influenced by the conditions of the atmosphere in which it operates. This Code requires recognition of the fact that changes in the ambient and other operating conditions will affect the equipment performance. Extraneous sources of heat and those variables which affect the air flow must be recorded and evaluated. It is extremely important that performance tests be conducted under stable operating conditions.

### 3.2 AGREEMENTS PRIOR TO TEST

The parties to any test under this Code shall reach definite agreement on the specific objective of the test and the method of operation. This shall reflect the intent of any applicable contract or specification. Contractual terms shall be agreed to concerning treatment of uncertainty relative to acceptance of equipment based on reported capability. Any specified or contract operating conditions, and/or any specified performance conditions that are pertinent to the objectives of the test, shall be ascertained. Any omissions or ambiguities as to any of the conditions are to be eliminated or their values or intent agreed upon before the test is started.

The parties to the test shall reach agreement, prior to the start of test, regarding the following items:

- (a) the specific methods and scope of inspection prior to and during the test;
- (b) the number of test runs and reading intervals;
- (c) the method for starting the test;
- (d) the method of operation of the equipment;
- (e) the fan blade settings;
- (f) the type, quantity, calibration, and location of all instruments;
- (g) the allowable bias in instrumentation and measurements, and the maximum permissible overall uncertainty in the test results (see Appendix C for discussion);

(h) the procedures and frequency for cleaning the air- and/or tube-side surfaces;

(i) the scope of the test beyond this Code, including partial testing or any other departures from this Code;

(j) the fouling factors to be assumed for analysis of results (see Appendix E).

### 3.3 SELECTION OF PERSONNEL

The test shall be conducted by, or under the supervision of, personnel fully experienced in plant and equipment operating procedures. The test procedure shall conform to the latest requirements of all applicable industry, local, state, and Federal regulations. Testing an air cooled heat exchanger presents potentially hazardous conditions which may include rotating equipment, high temperatures, hazardous fluids, noise, and danger of falling.

### 3.4 PRE-TEST UNCERTAINTY ANALYSIS

Prior to the test an uncertainty analysis shall be performed. An example of uncertainty analysis is included in Appendix C. The analysis is beneficial in that it will highlight those parameters that are major contributors to test uncertainty.

Parties to the test shall add or improve instrumentation or increase the frequency of readings if such actions will materially improve test accuracy.

### 3.5 ARRANGEMENT OF TEST APPARATUS

The performance test shall be conducted with all components of the ACHE oriented as specified for normal operation. Any changes from normal operation or orientation shall be agreed prior to the test.



### 3.6 METHODS OF OPERATION DURING TESTING

Although it is preferable to evaluate the performance of air cooled heat exchangers under complete design and steady-state conditions, this is normally not practicable for an on-site evaluation of this equipment. Therefore, prior agreement shall be established for procedures to adjust the test results to the design conditions as in para. 5.9.

### 3.7 PROVISIONS FOR EQUIPMENT INSPECTION

The information in para. 1.2 should be used as a guide in examination of the equipment prior to and during the test, with special attention to the following.

(a) Examine the general condition, as it affects the thermal performance and air flow.

(b) External heat transfer surfaces shall be essentially free of scale, dirt, oil, and other foreign debris that would affect the heat transfer and obstruct the air flow. If the need is established, the unit shall be cleaned by commercially acceptable methods.

(c) Internal heat transfer surfaces and headers shall be essentially clean and free of scale, rust, dirt, and other foreign matter. If the need is established, these surfaces shall be cleaned by commercially acceptable methods.

(d) Mechanical equipment shall be in good working order, and checked for freedom of movement. Fans shall be checked for proper rotation, blade pitch, speed, and tip clearance.

Provision shall be made to ascertain that all equipment and instruments are in good working order, free from defects and obstructions, and accessible, as required for repair, replacement, and observation. In the event the equipment is not in satisfactory operating condition, such adjustments or changes as may be required to place it in proper operating condition shall be made. However, no adjustments shall be made which are not practical in continuous commercial operation.

### 3.8 CALIBRATION OF INSTRUMENTS

All instruments to be used in the test shall be calibrated prior to the test. If the accuracy of any instrument is questionable during the test it shall also be calibrated after the test.

Prior to the test, the parties to the test shall reach agreement on the calibration procedures to be followed. Supplements on Instruments and Apparatus (PTC 19 Series) may be used as a guide for the selection, use, and calibration of instruments. Instrument calibrations and correction curves should be prepared in advance.

Removal and replacement of any instrument during the test may require calibration of the new instrument prior to continuing the test. All calibration curves shall be retained as part of the permanent test record.

### 3.9 PRELIMINARY TESTING

Preliminary or partial testing to evaluate certain aspects of the heat exchanger performance may be considered when a complete set of data is not required or is not applicable. This may include the following.

**3.9.1 Testing at Factory for Air Flow, Fan Performance, Sound Level, or Vibration.** Complete air flow and fan performance tests can be conducted at the factory and results adjusted to design conditions. Vibration and sound level measurements can be obtained to ensure mechanical performance within specification requirement.

**3.9.2 Testing at Factory for Process-Side Pressure Drop.** Design fluids can be circulated through the heat exchanger and pressure drop measured and results adjusted to design conditions.

**3.9.3 Substitute Fluid Testing.** Substitute fluid testing may be done for many reasons such as when the description of the process fluid is considered confidential or proprietary, when the process fluid is hazardous, or when economically justified. Substitute fluid testing is characterized by the use of fluids readily available, safe, and easily handled, and whose physical properties provide usable experimental data acceptable to both parties. The performance of an exchanger can be calculated from test data with a substitute fluid by the use of this Code. The adjustment of the test results, using the substitute fluid, to design conditions with the design process fluid is beyond the scope of this Code. When a substitute fluid is to be used for this purpose, it is suggested that a qualified consultant be retained to advise the parties to the contract, prior to purchase of the equipment, on the proper method of testing and interpretation of results.



### 3.10 CONDUCT OF TEST

Prior to the test, the equipment shall be operated long enough to establish steady-state conditions which are within permissible limits. No adjustments should be made to the equipment, or test procedures, which are not consistent with normal operation. The test should not be run if rain, snow, or severe wind conditions are present.

### 3.11 PERMISSIBLE AND NONPERMISSIBLE ADJUSTMENTS TO TEST PROCEDURES

No changes or adjustments to the test procedures shall be made unless all parties to the test agree. These adjustments might include a change in test conditions, a change in the arrangement of components of test, a change in instrumentation, a change in fan blade settings, a change in test schedule or number of readings required.

Once the test has started no manual changes or adjustments in the process fluid flow rate or air moving equipment shall be made. If permissible limits of test parameters have been exceeded, adjustments and changes may be made by mutual agreement of the parties to the test, and the test restarted when equilibrium has been reestablished.

### 3.12 DURATION OF TEST

Each test run shall be conducted in accordance with the predetermined schedule which fixes its duration, taking into account the instrumentation and number of observers available and the number of simultaneous readings that can be assigned without affecting the accuracy of the test. Inspection of the data from each test run should be made before terminating the run, so that any inconsistencies in the observed data may be detected and corrected. If valid corrections cannot be made, the test run shall be repeated.

Data shall be recorded for sufficient time to ensure a select period of at least one hour during which the provisions of paras. 3.13 through 3.16 are satisfied.

### 3.13 NUMBER OF TEST READINGS

All instrument readings required by this Code shall be taken after reaching steady-state process conditions. The number of readings per run will depend on the method of data acquisition, expected test uncertainty, and the size of the equipment. The number

of runs and the frequency of readings shall be determined by mutual agreement prior to the test.

### 3.14 PERMISSIBLE LIMITS OF TEST PARAMETERS

Performance tests shall be conducted within the following limitations<sup>1</sup>.

(a) Tests shall be made during periods of stable weather, not subject to rapid changes in air temperature, rain, snow, or high wind conditions.

(b) Average wind speed shall not exceed 10 mph with one minute averages not to exceed 15 mph. Wind direction and shift shall be within contractual agreement unless otherwise agreed upon by the parties to the test.

(c) Entering dry-bulb temperature shall be not more than 10°F above or 40°F below design dry-bulb temperature. The average change shall not exceed 5°F per hour.

NOTE: It must be recognized that the pour point or viscosity of the process fluid can govern the lower limit. Unless auxiliary equipment is provided to modify inlet air temperature, the lower entering air temperature limit shall not be less than 10°F above the process fluid pour point.

(d) The air flow shall be within  $\pm 10$  percent of the design value.

(e) Process fluid flow rate shall be within  $\pm 15$  percent of the design value, and shall not vary by more than 5 percent during the test.

(f) Process fluid inlet and outlet temperatures shall be within  $\pm 10^\circ\text{F}$  of the design values, and shall not vary by more than  $4^\circ\text{F}$  during the test.

(g) The process fluid temperature range shall be within  $\pm 10$  percent of the design value, and shall not vary by more than 5 percent during the test.

(h) For cooling gases or condensing vapors at pressures above atmospheric pressure, the process fluid inlet pressure shall be within  $\pm 10$  percent of the design value. For cooling gases or condensing vapors below atmospheric pressure, the parties to the test should agree to an acceptable pressure prior to conducting the test. For cooling liquids, any pressure up to the design pressure of the ACHE is acceptable; however, the pressure should not be so low that there is possibility of vaporization or degassing. The process fluid inlet pressure shall not vary by more than 10 percent during the test.

(i) Heat duty shall be within  $\pm 20$  percent of the design value.

<sup>1</sup>If any one of these limitations conflict with the basis of guarantee, these do not apply.

### 3.15 DEGREE OF CONSTANCY OF TEST CONDITIONS

Since the test of an ACHE may occur over an extended period, each test run shall be separately controlled to achieve steady-state conditions using fixed fan pitch, fan speed, and air flow control settings. Thus, each test run may be made at different steady-state operating conditions during the period of a complete performance test. Variations of operating parameters throughout the entire performance test shall be maintained as low as practicable, but must be maintained within the limits delineated in para. 3.14. Since the actual operating conditions will vary somewhat from the specific design conditions for the equipment, the test results must be adjusted to equivalent design conditions by the method shown in para. 5.9.

### 3.16 CAUSES FOR REJECTION OF TEST READINGS OR RESULTS

There are many conditions that affect the performance of an ACHE. Some adverse conditions could be a cause for rejection of test readings or results. These may include:

- (a) weather conditions of high wind, rain, snow, or extreme temperatures;
- (b) atmospheric conditions of dust, organics, or chemicals;
- (c) site interference from unspecified terrain, buildings, or other equipment;

(d) equipment or instrumentation failures, improper operation, wrong adjustments, or poor calibrations;

(e) poor test operating conditions resulting in excessive sound or vibration, low temperature differentials, condensate flooding, poor flow distribution, or air leakage;

(f) post-test uncertainty analysis indicating uncertainty of test results exceeding five percent;

(g) heat balance discrepancy calculated by Eq. (5.8) greater than 15 percent. If this occurs, an investigation of the equipment and instrumentation should be made to determine the cause for this discrepancy, and the test repeated.

All of the above factors shall be evaluated prior to and/or during the test to ascertain their effects on the system performance. The test should be deferred until satisfactory conditions exist which will enable accurate data to be obtained, or if the test cannot be performed within these limitations it may be necessary to establish revised limits for testing.

The performance test results shall be carefully reviewed within the context of the test agreement per para. 3.2 and the procedures and limitations described herein. If the test did not meet these criteria, it shall be voided unless otherwise mutually agreed.

### 3.17 POST-TEST UNCERTAINTY ANALYSIS

After the test, the uncertainty analysis shall be repeated based on actual variations of test data and degrees of freedom of the individual parameters.

## SECTION 4 – INSTRUMENTS AND METHODS OF MEASUREMENT

### 4.1 GENERAL

This Section describes choice of instruments, required sensitivity or precision of instruments, and calibration corrections to readings and measurements. Included are instructions as to methods of measurement, location of measuring systems, and precautions to be taken including critical timing of measurements to minimize error due to changing conditions. The Supplements on Instruments and Apparatus (PTC 19 Series) describe methods of measurement, instrument types, limits, sources of error, corrections, and calibrations. When appropriate, and to avoid repetition, this Code refers to and makes mandatory the application of the Supplements on Instruments and Apparatus (PTC 19 Series). All required instruments that are not covered by Supplements on Instruments and Apparatus have the rules and precautions described completely in this Section.

For any of the measurements necessary under this Code, instrumentation systems or methods other than those prescribed herein may be used provided they are at least as accurate as those specified herein. Other methods may be employed if mutually agreed. Any departure from prescribed methods shall be described in the test report.

### 4.2 MEASUREMENT OF PHYSICAL DIMENSIONS

The physical data shall be obtained for use in performance testing and evaluation. Most details for the tube bundle process side are defined in the ACHE data sheet. Other data may include:

- (a) face area;
- (b) ratio of free flow area to face area;
- (c) the total cross-sectional area for fluid flow in each pass.

### 4.3 FAN MEASUREMENTS

The fan speed shall be measured in accordance with the provisions of PTC 19.13, "Measurement of Rotary Speed." The fan ring diameter shall be measured along two perpendicular diameters a-c and b-d (see Fig. 4.1).

The following measurements may be taken for diagnostic purposes.

- Fan blade minimum tip clearance should be determined by rotating the fan 360 deg. and locating the minimum clearance of the longest blade.
- Fan blade maximum tip clearance should be determined by rotating the fan 360 deg. and locating the maximum clearance of the shortest blade.
- Blade track should be determined by moving each blade past a common vertical line on the fan ring inner wall. Results should be shown as vertical deviation from a selected horizontal datum plane.
- Fan blade angle should be measured (e.g., by means of a protractor equipped with a scale and level). The measurement should be made at the position on the blade specified by the fan manufacturer.
- Clearances and tracking of the blade tips should be measured at the equivalent dynamic position.

### 4.4 MEASUREMENT OF AIR FLOW

4.4.1 This measurement requires a traverse of air velocities over a selected area. Suitable instruments for the traverse include the propeller anemometer or a rotating vane anemometer. Pitot tubes may also be used for fan ring traverses, as described in PTC 11-1984. Instructions provided with the instrument must be followed so as to limit the overall test uncertainty to  $\pm 5$  percent. A minimum timed interval of 30 sec for individual readings is recommended. Since the direction of the air flow is not necessarily normal to

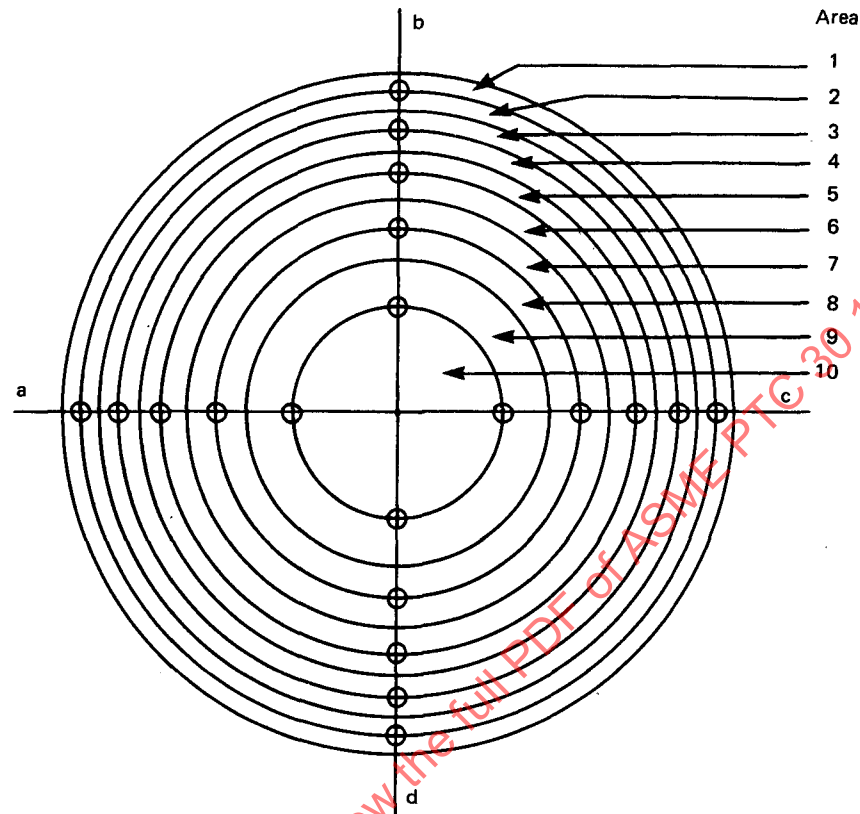

FIG. 4.1 LOCATION OF AIR VELOCITY AND TEMPERATURE MEASUREMENT POINTS ACROSS FAN RING

the plane of the area surveyed, it may be necessary to correct the readings for yaw. The anemometer shall be held parallel to the traverse plane, and the actual direction of air flow during the timed interval estimated. If the angle between the observed direction of air flow and the anemometer axis is 5 deg. or more, the reading shall be corrected. Specific corrections for yaw shall be determined by calibration prior to the test.

4.4.2 The selection of the most suitable area for the anemometer traverse shall be guided by the general physical arrangement, accessibility, obstructions, wind conditions, and air temperature rise. Because of the decreased effect of ambient wind, accuracy is usually better when the traverse is made in a high velocity stream. In the case where these constraints require that a velocity traverse be done at the inlet, a velocity traverse is also required at the exit in order to allow weighting the exit temperatures.

4.4.3 For induced draft units, air flow should be determined by traversing the streams emitting from the fans. The recommended minimum number of measurement points and the locations of these points are given in Table 4.1. Measurements along additional diameters may be necessary to avoid error due to the effects of structural members. For additional information on traversing methods, instrumentation, and evaluation of data, refer to PTC 18 and PTC 19.5.

To illustrate, a 20-point traverse (five measurement points per quadrant) is made as follows.

The plane bounded by the inner periphery at the top of the fan ring is divided into ten equal concentric areas numbered consecutively from 1 to 10 as shown in Fig. 4.1.

The ring is also divided into four quadrants as shown. The air velocity is then measured at each point of intersection of the radii a, b, c, and d with the inner peripheries of areas, 1, 3, 5, 7, and 9, at the center. The average velocities in combined areas 1 + 2, 3 + 4, 5 + 6, 7 + 8, and 9 + 10 are then obtained

**TABLE 4.1**  
**RECOMMENDED MINIMUM NUMBER OF AIR VELOCITY MEASUREMENT POINTS**  
**FOR FAN RING TRAVERSE**

Fan Ring Diameter, ft	Recommended Number of Concentric Areas for Traverse	Corresponding Measurements Per Quadrant	Corresponding Total Number of Measurements
4	6	3	12
6	8	4	16
8	10	5	20
12	10	5	20
16	10	5	20
20	12	6	24
24	14	7	28

Measurement Points Per Quadrant	Location of Measurement Points, Distance From Inner Wall of Fan Ring						
	Point 1	Point 2	Point 3	Point 4	Point 5	Point 6	Point 7
3	0.0436D	0.1465D	0.2959D	...	...	...	...
4	0.0323D	0.1047D	0.1938D	0.3232D	...	...	...
5	0.0257D	0.0817D	0.1465D	0.2261D	0.3419D	...	...
6	0.0213D	0.0670D	0.1181D	0.1773D	0.2500D	0.3557D	...
7	0.0182D	0.0568D	0.0991D	0.1464D	0.2012D	0.2685D	0.3664D

GENERAL NOTE: D is I.D. of fan ring at plane of traverse. Figure 4.1 illustrates the locations for the case in which five measurement points per quadrant are used.

by averaging the five measurements taken along the inner peripheries of areas 1, 3, 5, 7, and 9, respectively. These velocities are plotted against the total areas bounded by the corresponding circles as shown in Fig. 4.2.

The net area below the resulting curve, between the limits  $S_0$  and  $S_T$ , represents the actual volume of air delivered by the fan per unit of time.

If mutually agreed upon by the parties to the test, the foregoing procedure for determining the air flow rate may be simplified by averaging directly the 20 air velocities (the reading at the center of the fan is not used in this method) and multiplying the resulting number by the total fan ring area  $S_T$ .

**4.4.4** In some instances, obstructions in the fan ring, or inaccessibility, prevent the use of the fan ring traverse method, and a traverse of the tube bundle is indicated. The measurement plane chosen shall be divided into imaginary rectangular areas (at least 20 or one per 12 sq ft, whichever is greater) with the same aspect ratio as the plane being measured, if practical. The summation of the products of the small areas and the corresponding velocities at their centers will approximate the total volumetric flow of air.

For forced draft units an exit traverse is normally required, in conjunction with temperature measurements, so that the weighted exit temperature can be determined (see para. 4.13).

If the traverse measurements are made in a plane upstream from the tube bundle face (typical for induced draft units), the plane shall be located at least five prime tube diameters from the extremities of the fins to prevent error due to the restriction effect of the tubes; for downstream traverses (typical for forced draft units) the required minimum distance is 15 prime tube diameters. To minimize error due to wind effect a suitable shield is necessary in most instances (Ref. [1]).

#### 4.5 MEASUREMENT OF AIR-SIDE PRESSURE DIFFERENTIAL

Normally a Code test will not require the determination of air-side pressure drop. This measurement is usually taken to diagnose a performance problem, or in the event that the parties to the test have agreed to guarantee the total or static differential pressure losses.



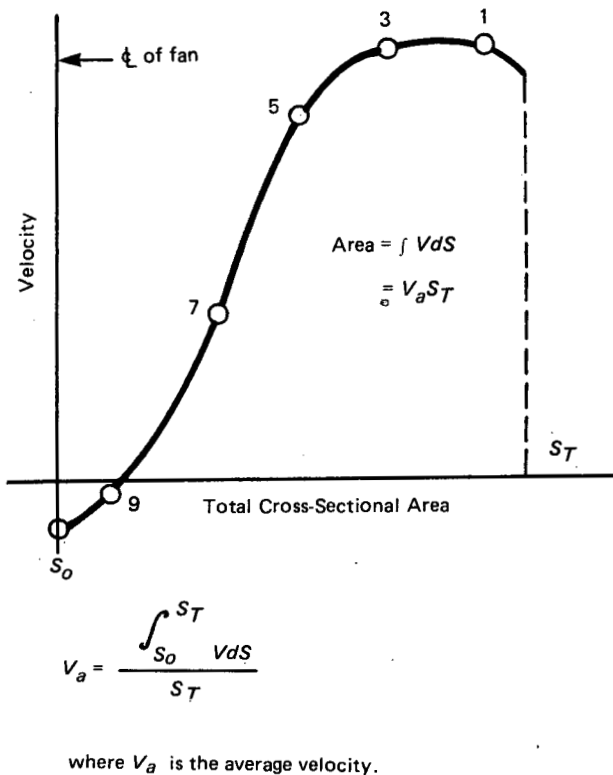

**FIG. 4.2 TYPICAL VELOCITY DISTRIBUTION ACROSS FAN STACK**

**4.5.1** The static pressure drop resulting from the passage of air through the unit shall be measured by means of probes designed to minimize velocity effect, and a suitable readout device such as an inclined tube manometer, sufficiently accurate to yield readings within  $\pm 5$  percent of the true values.

**4.5.2** A wall tap, comprised of a smooth 1/8 in. diameter drilled hole without burrs or obtrusions is suitable in uniform low velocity flows; however, the use of a cylindrical Fechheimer probe or a two- or three-dimensional wedge probe is recommended (see PTC 11-1984, Fans for further information). The probe shall be calibrated before each use.

If an accurate static pressure measurement is necessary, a traverse using the procedures described in para. 4.4 is required.

**4.5.3** The manometer shall be an inclined tube gage calibrated for direct readings in inches of water. The scale range shall be selected to suit the magnitude of

the readings and of such size that they may be read to 5 percent of the anticipated value.

**4.5.4** For the readings a probe shall be connected to each leg of the manometer. The instrument shall first be checked for zero deflection, with the probes located at approximately the same vertical distance apart as will exist during the readings.

**4.5.5** For induced draft ACE's, the high pressure side will be sensed by the probe located at the inlet side of the tube bundle. This pressure should be fairly constant and, after proving consistency of reading, the low pressure probe is positioned and the static pressure differential recorded.

**4.5.6** For forced draft ACE's the low pressure side will be sensed by the probe located at the heat exchanger outlet. The low pressure area should exhibit fairly constant pressure; once constancy is verified, the probe should be left in position for duration of differential pressure measurements. The high pressure side to be probed will be at the fan discharge, and the probe should be positioned at the fan discharge area at a location sufficiently downstream of fan to minimize severe turbulence.

#### 4.6 MEASUREMENT OF FAN DRIVER POWER

Test power is the shaft output of the prime mover. For electric motors, test measurements are made at the input, and the output power is computed by multiplying input power by motor efficiency. Acceptable instruments for determining power, in preferred order, are:

- (a) wattmeter
- (b) voltage, current, power factor meters

When readings are taken at a load center located a substantial distance from the motors, corrections should be made by direct measurement of voltage drop (or by computation of loss) between load center and motor. To enable this correction to be made, the length and gage of cable involved should be measured. A measured or computed voltage drop between the load center and one motor may be applied to the other motors by ratioing their distances from the load center.

For prime movers other than electric motors, the method for determining power shall be mutually agreed upon prior to the test.

#### 4.7 MEASUREMENT OF SOUND LEVEL

This subject is treated in PTC 36-1985.

#### 4.8 MEASUREMENT OF ATMOSPHERIC PRESSURE

Atmospheric pressure shall be measured by means of a mercury barometer.

If mutually agreed by the parties to the test, the barometric pressure may be obtained from a nearby weather bureau station. If this method is used, it is necessary to establish whether the readings given are for *station* or *sea level* pressure. The readings obtained shall be corrected for the difference in elevation of the barometer and the unit being tested. Results shall be based on atmospheric pressure at station level. Readings may be corrected to sea level if desired. Details of the procedure for correction are given in PTC 19.2.

#### 4.9 MEASUREMENT OF ENVIRONMENTAL EFFECTS

Prior to the test, a survey of the area surrounding the unit shall be conducted jointly by the parties to the test. All conditions that may contribute to variations in performance, such as heat sources affecting inlet air temperature, and nearby buildings or structures which may cause air currents that result in warm air recirculation, or in reduced fan performance, shall be investigated. Measurements necessary to map these effects during the test shall be determined by mutual agreement, and substantiating test data shall be obtained as necessary. Ambient temperature measurements shall be taken in accordance with paras. 4.11 and 4.12 of this Code. Measurements should be made in all locations, simultaneously if possible, or in rapid succession. If such locations are not accessible or the area surrounding the ACHE contains elements (see above) which can affect the ambient temperature, a suitable location for these measurements shall be mutually agreed upon.

#### 4.10 MEASUREMENT OF WIND VELOCITY

The instrument recommended is either the rotating cup or rotating vane anemometer with preferably a continuous readout or recording capability. A loca-

tion should be chosen for the measurement that is unobstructed upwind and at an elevation approximately midway between the average air inlet plane elevation and the average air exit plane elevation. If such a location is impracticable, an alternate location may be agreed upon by the parties to the test.

#### 4.11 MEASUREMENT OF AIR TEMPERATURES

4.11.1 PTC 19.3 shall be used to stipulate satisfactory instrumentation and details of construction of sensor wells, the reading of the instruments, and their calibration and corrections.

The uncertainty of temperature measurements shall not exceed the larger of the following values:

- (a) 0.2°F, or
- (b) two percent of the smallest of the following three key temperature differences:
  - (1) the temperature range of the process fluid (unless isothermal)
  - (2) the temperature range of the air
  - (3) the minimum approach temperature difference.

Satisfactory instruments include suitable ASTM mercury-in-glass thermometers, thermocouples, calibrated sensors with signal conditioner such as resistance temperature devices or thermistors, or equivalent.

The sensing elements shall be exposed to the atmosphere, but shielded from direct sunlight or other radiation source by means of an opaque shield.

4.11.2 The wet-bulb temperature measuring instruments should be mechanically aspirated and incorporate the following features:

- (a) A calibrated temperature sensor whose uncertainty is less than  $\pm 0.1^\circ\text{F}$  in the range of the expected test temperatures.
- (b) Sensing elements shielded from direct sunlight or other radiation source. The inner side of the shield shall be essentially at the dry-bulb temperature.
- (c) Wicking covering the sensor shall be clean and continuously supplied from a reservoir of distilled or demineralized water. The wick shall be a snug fit and extend at least 1 in. over the active portion of the sensor.
- (d) The temperature of the water used to wet the wick shall be at approximately the wet-bulb temperature.
- (e) The air velocity over the wick shall be continuous at approximately 1000 ft/min.



#### 4.12 MEASUREMENT OF AMBIENT AND ENTERING AIR TEMPERATURES

This survey shall consist of two ambient wet- and dry-bulb temperature measurements and a suitable number of entering dry-bulb temperature measurements.

The ambient wet- and dry-bulb temperature measurements shall be taken at approximately 5 ft above the ground elevation not less than 50 or more than 100 ft upwind of the equipment. These shall be spread along a line which brackets that flow. If these locations are inaccessible or contain elements which can affect the reading of wet-bulb temperature, alternate locations shall be mutually agreed upon.

Entering dry-bulb temperature measuring stations shall be selected on an equal-area basis, and shall be located in a plane 6 in. below the fan ring for forced draft, and 12 in. below the finned tubes for induced draft units. The sensing elements of the thermometers, or thermocouples, shall be properly located and shielded to prevent appreciable error due to radiation. The recommended number of stations is given in para. 4.4. If the maximum and minimum temperatures differ by 5°F or more due to warm air recirculation, or environmental effects, additional stations shall be selected, the number and location of these stations shall be determined by mutual agreement of the parties to the test.

#### 4.13 MEASUREMENT OF EXIT AIR TEMPERATURE

Unless otherwise agreed by the parties to the test, coincident temperatures and velocities shall be measured at all selected stations so that the weighted exit air temperature can be calculated. The instruments to be used shall be as specified in para. 4.11.

**4.13.1 Induced Draft Units.** Measurement stations shall be located prior to the test period in accordance with para. 4.4.3 so that the measurements will best represent the true bulk temperature. For multiple-fan units, fewer stations may be used if agreed upon by the parties to the test. The temperature profile of one fan shall be investigated thoroughly prior to the test period to ensure sufficient accuracy; the data shall be made a part of the test report.

**4.13.2 Forced Draft Units.** Measuring stations shall be located downstream of the tube bundles. The measurement plane shall be divided into imaginary

rectangular areas (at least 20 or one per 12 square feet, whichever is greater) with the same aspect ratio as the plane being measured, if practical. Shields shall be provided for the temperature sensing elements to prevent error due to dilution by outside air, or due to radiation from the sun or other sources. The temperature measurement devices shall be located a sufficient distance from the ACHE to minimize the effect of the tube wakes (usually 15 prime tube diameters is sufficient).

#### 4.14 MEASUREMENT OF PROCESS FLUID TEMPERATURES

**4.14.1** The uncertainty of temperature measurements shall not exceed the larger of the two following values:

- (a) 0.2°F, or
- (b) two percent of the smallest of three key temperature differences;
  - (1) the temperature range of the process fluid (unless isothermal)
  - (2) the temperature range of the air, or
  - (3) the minimum approach temperature difference. See para. 4.11 for satisfactory instruments.

**4.14.2** The measuring stations shall be located close enough to the unit to prevent appreciable error due to temperature change occurring between the stations and the unit. Where stratification is a possibility, preliminary tests shall be conducted to determine the magnitude of possible resultant error. These shall be made a part of the test report.

#### 4.15 MEASUREMENT OF PROCESS FLUID PRESSURES

The required uncertainty limit of fluid pressure measurement devices shall be two percent of the absolute fluid pressure. Instrument selection and details of measurement techniques shall be made in accordance with PTC 19.2. Satisfactory instruments include pressure gages, manometers, pressure transducers, or other equivalent devices.

Measuring stations shall be located as close to the unit as practicable. Corrections shall be made for line losses, fitting losses, etc., that result in pressure difference between the measuring stations and the unit.



#### **4.16 MEASUREMENT OF PROCESS FLUID FLOW RATE**

**4.16.1** The recommended uncertainty limit of fluid flow measurement devices shall be two percent of the total process flow through the test unit. Instrument selection and details of measurement techniques shall be in accordance with PTC 19.5. Satisfactory instruments include venturi meters, orifice meters, flow nozzles, pitot tubes, turbine meters, or other equivalent devices.

Alternatively, flow rates may be determined by plant heat balance method, provided the uncertainty does not exceed two percent.

**4.16.2** Measurements shall be made in the piping leading to and as close as possible to the unit. If this is not practicable, an alternate location shall be selected by mutual agreement, and corrections made as necessary to determine the actual flow into the unit.

#### **4.17 MEASUREMENT OF COMPOSITION OF PROCESS FLUID**

Sufficient samples of the process fluid shall be obtained to enable determination of the composition of inlet and outlet streams. The methods of analyses shall be mutually agreed upon by the parties to the test.

INTENTIONALLY LEFT BLANK

ASMENORMDOC.COM : Click to view the full PDF of ASME PTC 30 1997

## SECTION 5 — COMPUTATION OF RESULTS

### 5.1 GENERAL

This Section covers the reduction of the test data, computation of test results, adjustment of results to design conditions, and interpretation of adjusted results by comparing them to design. This Section assumes that theACHE surface is of a typical circular geometry. If not, the parties to the test must adjust the computations as appropriate. The basic procedure for computation of performance capability is:

- (a) review the raw test data and select the readings to be used on the basis of the requirements of paras. 3.12 through 3.17;
- (b) average the selected data;
- (c) compute mass and heat balances, and establish whether or not the provisions of paras. 3.14 through 3.16 have been met;
- (d) compute test value of effective mean temperature difference;
- (e) compute overall heat transfer coefficient at test conditions;
- (f) establish individual resistances at test conditions;
- (g) adjust air flow rate and air film resistance to design fan power and design air density;
- (h) adjust test process-side pressure drop to design conditions, and compare to specification value;
- (i) compute the capability of the unit at design process temperatures, design inlet air temperature, and design fan power. The method presented is an iterative one, since corresponding heat load, process flow rate, inside film resistance, and effective mean temperature difference are all unknown.

### 5.2 REVIEW OF TEST DATA AND TEST CONDITIONS

The raw test data shall be carefully reviewed to ensure selection of entries that will accurately represent true performance. This review should be started at the beginning of the test, providing an op-

portunity for immediate discovery of possible errors in instruments, procedures, and methods of measurement. Guidance for the review of data and test conditions is given in paras. 3.12 through 3.16; significant deviations shall be corrected prior to the official data collection if practicable. Any uncorrected or uncontrollable conditions that violate the provisions of paras. 3.12 through 3.16 shall be described in the test report. At the end of the test period, but prior to removal of test instrumentation, a final review of the data shall be made to determine whether or not an immediate repeat test is necessary. This review will also assist in the establishment of the reliability of the test; it shall include a post-test uncertainty analysis for evaluation of deviations from ideal of the following, and the effects of these deviations on the test results:

- (a) comparison of test and design conditions;
- (b) test site environment, including atmospheric conditions;
- (c) fouling;
- (d) leakage, process-side and air-side;
- (e) process fluid distribution;
- (f) air distribution;
- (g) steady-state conditions;
- (h) measurement uncertainty;
- (i) location of measurement stations;
- (j) qualifications of test personnel, and validity of test data;
- (k) process fluid composition.

### 5.3 REDUCTION OF TEST DATA

The purpose of averaging the raw test data is to give a single set of numbers which is representative of the collected data to be used in calculations to determine performance. Multiple readings taken over time and/or readings of the same parameter by multiple instruments at a given station shall be arithmetically averaged.

### 5.3.1 Air-Side Data Reduction

(a) *Air Velocity.* Individual air velocity measurements shall be corrected for instrument calibration and then averaged as discussed in para. 4.4

(b) *Air Temperature.* Air temperature data readings shall be averaged for each set of test data. Exit air temperatures shall be averaged by the mass flow weighted average method shown in Eq. (5.1); however, variations in inlet air temperature are normally small enough to allow arithmetical averaging of the temperatures alone.

$$t = \frac{\sum_{n=1}^N t_n \rho_n V_n S_n}{\sum_{n=1}^N \rho_n V_n S_n} \quad (5.1)$$

where  $n$  is an individual measurement

(c) *Static Pressure or Differential Pressure.* The readings shall be arithmetically averaged.

### 5.3.2 Process Fluid Data Reduction

(a) *Process Temperatures.* Readings of process fluid temperatures at a given station shall be arithmetically averaged.

(b) *Process Flow.* Process flow measurements shall be calculated in accordance with ASME PTC 19.5, Fluid Flow Measurement Procedures, or its interim supplement, ASME Fluid Meters, Part II.

(c) *Process Pressure.* Process pressure measurements shall be calculated in accordance with ASME PTC 19.2.

## 5.4 DETERMINATION OF MATERIAL AND HEAT BALANCES

Both the air-side and process-side heat loads are to be calculated. The objectives of these calculations are two-fold: (1) to determine the heat load of the heat exchanger under the test condition, and (2) to check the validity of the set of test data obtained. To calculate the heat loads for both the air and process sides, the air and process fluid mass flow rates are first calculated. These flow rates are then used to calculate the heat loads.

### 5.4.1 Air-Side Mass Flow Rate and Heat Load

(a) *Computation of Mass Flow Rate of Dry Air.* For computation of air mass flow rate,

$$w = (\rho_a)(V_a)(S_a)(60) \quad (\text{Note 1}) \quad (5.2)$$

<sup>1</sup>The factor 60 applies to U.S. Customary units of  $\rho_a$ ,  $V_a$ ,  $S_a$ .

The density of dry air can be calculated from

$$\rho_a = 1.325 B/t_R \quad (\text{Note 2}) \quad (5.3)$$

(b) *Computation of Heat Load:*

$$Q_a = (w)(H_{a2} - H_{a1}) \quad (\text{Note 3}) \quad (5.4)$$

### 5.4.2 Computation of Process-Side Mass Flow Rate and Heat Load

(a) *Computation of Mass Flow Rate*

$$W = (\rho_p)(V_p)(S_p)(60) \quad (5.5)$$

(b) *Computation of Heat Load*

$$Q_p = (W)(H_{p1} - H_{p2}) \quad (5.6)$$

The enthalpy of the process fluid at the entrance and at the exit shall be determined by means, and from data sources, mutually agreed upon by the parties concerned prior to the test. For process fluids with no phase change, the above heat load equation can be written

$$Q_p = (W)(c_p)(T_1 - T_2) \quad (5.7)$$

**5.4.3 Computation of Heat Balance Error.** The percent error in heat balance is calculated by

$$\text{Percent Error} = \frac{|Q_p - Q_a|}{Q_p + Q_a} \times 200 \quad (5.8)$$

$|Q_p - Q_a|$ , is the absolute value

If the percent error is within the acceptable limit of 15 percent as stated in para. 3.16, the heat load  $Q$  to be used for data interpretation can be one of the following:

- the air side heat load  $Q_a$
- the process side heat load  $Q_p$
- the average heat load  $(Q_a + Q_p)/2$ .

<sup>2</sup>The constant 1.325 applies for U.S. Customary Units of  $B$  and  $t_R$ , i.e., in. Hg and R.

<sup>3</sup>Values of  $H_{a1}$  and  $H_{a2}$  are determined from enthalpy data, using the corresponding test values of  $t_1$  and  $t_2$ .

The selection of  $Q$  shall be based upon the value that provides the lowest estimated overall uncertainty.

If the percent error is not within acceptable limits, no further calculations are advisable and the test shall be repeated, unless otherwise agreed.

$$\text{EMTD} = \frac{Q}{\sum_{n=1}^N \frac{Q_n}{\text{EMTD}_n}} \quad (5.13) \text{ (Note 4)}$$

where  $n$  denotes the individual zone

For cases where the overall heat transfer rate varies through the unit, such as changes from turbulent to laminar flow or units with condensing and subcooling, then it is necessary to divide the unit into zones and treat each zone as a separate case. This involves obtaining a separate heat load, EMTD and  $U$  for each zone. This type of operation may require special temperature measurements within each zone rather than only recording the inlet and outlet terminal temperatures of each stream. These intermediate temperatures may be impractical to obtain. In such cases prior agreement should be reached between the parties involved concerning the actual data reduction procedures.

In the typical air cooled heat exchanger design, the flow arrangement is not normally pure countercurrent or cocurrent. Most designs are fabricated for air flow at right angles to the tubes and crossing over one or more tube rows in series. The process fluid in the tubes, at any one point, travels at right angles to the air flow, and the correction factor  $F$  is usually less than one.

The correction factor  $F$  for the most common arrangements may be obtained from Figs. 5.1 through 5.8. Correction factors are only applicable for the flow arrangements shown in the figures. All of these figures are predicated on using the countercurrent flow formula for calculating the LMTD.

For other types of flow, not covered by these figures, the calculation of  $F$  shall be a matter of agreement of the parties involved in the test. If the process fluid temperature is constant, the EMTD is calculated by Eq. (5.12).

## 5.5 COMPUTATION OF EFFECTIVE MEAN TEMPERATURE DIFFERENCE

EMTD is the effective mean temperature difference between the hot stream and the air stream.

$$\text{EMTD} = F \times \text{LMTD} \quad (5.9)$$

where

$F$  = correction factor for deviation from true countercurrent or cocurrent flow

LMTD = Logarithmic Mean Temperature Difference

For strictly countercurrent flow or cocurrent flow and for cases where the temperature of the process stream is constant, the LMTD is calculated from

*Countercurrent Flow:*

$$\text{LMTD} = \frac{(T_1 - t_2) - (T_2 - t_1)}{\ln \left( \frac{T_1 - t_2}{T_2 - t_1} \right)} \quad (5.10)$$

*Cocurrent Flow:*

$$\text{LMTD} = \frac{(t_1 - t_1) - (T_2 - t_2)}{\ln \left( \frac{T_1 - t_1}{T_2 - t_2} \right)} \quad (5.11)$$

*Constant Process Fluid Temperature:  $T_1 = T_2 = T$*

$$\text{LMTD} = \frac{(t_2 - t_1)}{\ln \left( \frac{T - t_1}{T - t_2} \right)} \quad (5.12)$$

Where  $U$  is essentially constant over a temperature range, but release of heat versus temperature is a curved line, the heat release curve may be divided into zones using a straight line release in each zone. With this situation, the EMTD for the whole unit is calculated from the following equation:

## 5.6 COMPUTATION OF OVERALL HEAT TRANSFER COEFFICIENT

$U_r^o$  is calculated from

$$U_r^o = \frac{Q^o}{(A_r) (\text{EMTD}^o)} \quad (5.14)$$

where  $Q^o$  is the test heat load, expressed in Btu/hr, selected as best representing the thermal duty of the heat exchanger. The value used must always be

\*This procedure is fundamentally correct only for pure countercurrent or cocurrent flow, but yields an approximate answer without requiring detailed stepwise calculations. It may be used with mutual agreement of the parties to the test; otherwise, another agreed procedure may be used.

clearly identified, e.g., *air-side*, *process-side*, *arithmetic average*, etc.

The reference area may be any convenient mutually agreed upon heat transfer surface. There are four commonly used reference areas.

### 5.6.1 Total Outside Heat Transfer Area Including Fins ( $A_o$ )

$$A_o = [(N) (N_{fin}) (L_{in}) \left(\frac{\pi}{2}\right) (D_{fin}^2 - D_{ro}^2)] \\ + [(N) (L_{in}) (\pi) (D_{ro}) (1 - N_{fin} f_r)] \\ + [(N) (\pi) (D_{po}) (L - L_{in})] \quad (5.15)$$

where

$L_{in}$  = the length of finned portion of tube

$D_{fin}$  = the outside diameter of fin

$D_{ro}$  = the outside diameter of root

$D_{po}$  = the outside diameter of prime tube

$L$  = the total length of tube

(Note: Other symbols as defined in para. 2.2)

### 5.6.2 Outside Surface Based on Fin Root Outside Diameter ( $A_{ro}$ )

(This is a fictitious area)

$$A_{ro} = \pi N D_{ro} L_{in} \quad (5.16)$$

### 5.6.3 Prime Surface Based on Inside Tube Diameter ( $A_{pi}$ )

$$A_{pi} = \pi N D_i L \quad (5.17)$$

### 5.6.4 Prime Surface Based on Outside Tube Diameter ( $A_{po}$ )

$$A_{po} = \pi N D_o L \quad (5.18)$$

The reference area upon which the overall heat transfer coefficient is based must be clearly identified in connection with any statement of that coefficient.

The overall heat transfer coefficient is meaningful only if all of the assumptions required for the mean temperature difference formulation are satisfied.

## 5.7 DETERMINATION OF AIR-SIDE PRESSURE LOSSES

The summation of the air pressure losses of the tube bundle, flow obstructions, and air turning losses

is equal to the air pressure rise provided by the fan. Therefore, to measure the cooling system air pressure loss, one can either measure these component losses separately or in combination, or one can deduce the total losses from the fan drive system power consumption and the measured airflow. The fan drive system power consumption is comprised of the air energy losses and the drive system mechanical and electrical energy losses. Generally, in a performance test, it may not be necessary or desirable to measure each of these air pressure losses separately, and usually it is preferable and easier to measure only the cooling system power consumption for comparison with design specifications and/or performance characteristic data provided by the system supplier.

## 5.8 DETERMINATION OF PROCESS FLUID PRESSURE LOSSES

The pressure loss between measuring stations is simply the difference between the measurements taken at these locations. The test measuring stations should be located in such a way that they will provide a pressure measurement at the required design stations. If not, consideration must be given to the effects of the following factors:

- gravity
- fluid velocity
- flow obstructions
- fluid properties and flow rates

Figure 5.9 is a schematic representation of the process fluid piping for an ACHE. The measuring stations (MS) and design stations (DS) have been deliberately depicted in different vertical locations in order that the following discussion and calculation procedures can encompass this possibility.

Equation (5.19) shall be used to adjust the test value of pressure loss across the measuring stations, to a deduced value of total pressure loss across the design stations at the test conditions.

$$\Delta P_{DS\text{test}} = [\Delta P_{ms\text{test}} - (\Delta P_{gM-D} + \Delta P_{gD-D} + \Delta P_v)] \times \frac{\Delta P_{OBDS}}{\Delta P_{OBMS}} \quad (5.19)$$

where:

$\Delta P_{ms\text{test}}$  is the process fluid pressure differential as measured by experimental data at the selected measuring stations.

$\Delta P_{gM-D}$  is the change in the measured process fluid pressure differential caused by differences in elevations between the measuring stations and design stations and/or differences in process fluid densities in the inlet piping and the outlet piping.



$\Delta P_{gD-D}$  is the change in the measured process fluid pressure differential between design stations caused by differences in elevation of the design stations and/or differences in processing fluid densities in the inlet piping, the outlet piping, and in the bundles. It may not be necessary to include this term depending on how the pressure drop is quoted.

$\Delta P_v$  is the change in the measured process fluid pressure differential if static pressures are measured.

$\Delta P_{DS_{test}}$  is the deduced process fluid total pressure loss at the test conditions.

$\Delta P_{OB_{DS}}$  is the sum of all the flow resistances due to obstructions between design stations.

$\Delta P_{OB_{MS}}$  is the sum of all the flow resistances due to obstructions between measuring stations.

Detailed procedures for solving the elements of Eq. 5.19 are presented in the following paragraphs.

**5.8.1 Gravity ( $\Delta P_g$ ).** Differences in elevations and/or densities will have an effect on process fluid pressure measurements. These effects can be evaluated by means of Eqs. (5.20) and (5.21) with reference to Fig. 5.9.

$$\Delta P_{gM-D} = \Delta E_{1DM} \rho_1 - \Delta E_{2DM} \rho_2 \quad (5.20)$$

$$\Delta P_{gD-D} = \Delta E_{1BD} \rho_1 - \Delta E_B \left( \frac{\rho_1 + \rho_2}{2} \right) - \Delta E_{2BD} \rho_2 \quad (5.21)$$

**5.8.2 Fluid Velocity ( $\Delta P_v$ ).** If total pressures are measured,  $\Delta P_v$  is included in the total pressure. If static pressures are measured,  $\Delta P_v$  can be evaluated using Eq. (5.22).

$$\Delta P_v = \frac{\rho_2 V_2^2 - \rho_1 V_1^2}{2 g_c (3600)} \quad (5.22)$$

where:

$\Delta P_v$  = velocity pressure differential, lbf/ft<sup>2</sup>

**5.8.3 Flow Obstruction ( $\Sigma \Delta P_{OB}$ ).** Obstruction losses between measuring stations may include effects due to:

- (a) pipe and bundle tube friction
- (b) contractions and/or expansions in the pipes and bundle tubes
- (c) pipe and bundle tube bends
- (d) the presence of fittings such as bends, valves, flow meters, tees, couplings, etc.

These losses can be evaluated at the test conditions using the following equations and recommendations:

**5.8.3.1 Pipe and Bundle Tube Friction ( $\Delta P_{OB-1}$ ).** These losses can be calculated using Eq. (5.23).

$$\Delta P_{OB-1} = \frac{f_M L \rho V^2}{2 D_i g_c (3600)} \quad (5.23)$$

Properties should be evaluated at the mean temperature. For evaluation of friction factor,  $f_M$ , refer to Fig. D.1, Appendix D.

**5.8.3.2 Obstruction Losses Due to Contractions, Expansions, Bends, and Fittings ( $\Delta P_{OB-2}$ ).** These losses can be calculated using Eq. (5.24).

$$\Delta P_{OB-2} = \frac{K \rho V^2}{2 g_c (3600)} \quad (5.24)$$

The evaluation of  $K$  will depend on the type of obstruction as described below.

Abrupt contraction and expansion losses yield a value of  $K$  as follows:

$$K = 0.5 \times (1 - \beta^2) \text{ in contraction} \quad (5.25)$$

$$K = (1 - \beta^2)^2 \text{ in expansion} \quad (5.26)$$

where  $\beta$  is the ratio of the smaller to the larger inside pipe diameter.

**5.8.3.3 Pipe and Cooler Tube Bend Losses ( $\Delta P_{OB-3}$ ).** These losses yield a  $K$  coefficient which is not explicitly defined by any correlation. Reference [2], however, presents some data for 90 deg. bends along with a correlation for more than one bend in series which is not simply the sum of the number of 90 deg. bends.

**5.8.3.4 Losses Caused by Various Fittings ( $\Delta P_{OB-4}$ ).** The values of the loss coefficient,  $K$ , for pipe fittings, valves, etc., are dependent on the specific geometry involved and cannot be generalized. For this reason it is best to plan the instrumentation so that there are as few such losses as possible between measuring stations. For those components which must be evaluated, there are data available from manufacturers, such as Ref. [3], and reference will have to be made to these for the particular type of fitting of interest.

Summarizing,

$$\Sigma \Delta P_{OB} = \Delta P_{OB-1} + \Delta P_{OB-2} + \Delta P_{OB-3} + \Delta P_{OB-4}$$

## 5.9 ADJUSTMENTS OF TEST DATA TO DESIGN CONDITIONS

Since tests are rarely run at design conditions, the recommended procedure is to adjust the ACHE performance results determined under test conditions to design conditions and compare these adjusted values with the design values.

When a procedure for acceptance testing is to be adopted, a discussion between the interested parties is essential to establish agreement as to the method by which data will be adjusted from test to design conditions. Presented below are methods which may be used to make adjustments required in some of the more commonly encountered situations. Before using these methods, the parties involved in the testing should assure their applicability to the test under consideration. Adjustments for some of the more complex cases can be made using the relationships in Appendix D.

**5.9.1 Adjustment of Air-Side Bundle Pressure Drop and Fan Performance.** When the test is run at conditions other than design air densities, velocities, or fan speed, test measurements may be adjusted to their equivalent values at design conditions by use of the following equations. The user should recognize that accuracy may suffer if adjustments are made from conditions which vary significantly from design conditions (see limitations in paras. 3.14 and 3.15).

### (a) Air-Side Bundle Pressure Drop

$$\Delta p_s^+ = \Delta p_s^o \times \left( \frac{V^*}{V^o} \right)^{1.7} \times \frac{(\rho_1 + \rho_2)^*}{(\rho_1 + \rho_2)^o} \quad (5.27)$$

or

$$\Delta p_s^+ = \Delta p_s^o \times \left( \frac{\text{RPM}^*}{\text{RPM}^o} \right)^{1.7} \times \frac{(\rho_1 + \rho_2)^*}{(\rho_1 + \rho_2)^o} \quad (5.28)$$

Because of the simplifying assumptions made in the derivation, significant changes in the Reynolds number,  $V$ , or RPM, between design and test conditions will adversely affect accuracy. The 1.7 power has been established as reasonable approximation empirically, but may vary given different system configurations.

### (b) Fan Power Adjustments

$$\text{Fan Horsepower}^+ = \text{Fan Horsepower}^o \times \frac{(\rho_1 + \rho_2)^*}{(\rho_1 + \rho_2)^o} \times \left( \frac{V^*}{V^o} \right)^{2.7} \quad (5.29)$$

$$\text{Fan Horsepower}^+ = \text{Fan Horsepower}^o \times \frac{(\rho_1 + \rho_2)^*}{(\rho_1 + \rho_2)^o} \times \left( \frac{\text{RPM}^*}{\text{RPM}^o} \right)^{2.7} \quad (5.30)$$

NOTE: The cautions presented above applicable to the pressure drop evaluation are also applicable to the power adjustments.

Adjusted driver input horsepower may be obtained by introducing the driver and drive train efficiencies.

$$\text{Driver Input Horsepower}^+ = \frac{\text{Fan Horsepower}^+}{\eta_{\text{driver}} \eta_{\text{drive train}}} \quad (5.31)$$

### (c) Air Density Determinations

For determining the densities required in the pressure drop and horsepower adjustments, Eq. (5.3) may be used.

NOTE: This equation is used for the more typical applications and neglects humidity effects. If widely variant humidity conditions exist with respect to design, a more precise evaluation using psychrometric data may be appropriate.

### (d) Air Flow Determination

To adjust the test air flow to the conditions of design fan horsepower and design air density, use

$$w^+ = w^o \left( \frac{\text{HP}^*}{\text{HP}^o} \right)^{1/2.7} \left( \frac{\rho_2^o}{\rho_1^o} \right)^{2/3} \quad (5.32)$$

## 5.9.2 Adjustments of Single Phase Process-Side Fluid Pressure Drops

NOTE: For multi-phase cases, the user should refer to Appendix D

To compare the measured process-side pressure drop to the design value, adjustments may be necessary to compensate for the following:

- Process fluids with properties or conditions other than design
- Process flow rates other than design

Such adjustments may be made using

$$\Delta P_p^+ = \Delta P_p^o \left( \frac{V_p^*}{V_p^o} \right) \left( \frac{\rho_p^o}{\rho_p^*} \right) \left( \frac{\mu_p^o}{\mu_p^*} \right), \text{ for laminar flow} \quad (5.33)$$

$$\Delta P_p^+ = \Delta P_p^o \left( \frac{V_p^*}{V_p^o} \right)^{1.8} \left( \frac{\rho_p^o}{\rho_p^*} \right) \left( \frac{\mu_p^o}{\mu_p^*} \right)^{0.2}, \text{ for turbulent flow} \quad (5.34)$$



Densities and viscosities should be evaluated at the mean temperature.

## NOTES:

- (1) This adjustment presumes that inlet and outlet pressures were measured at their design locations within the system. If this is not the case, adjustments must be made in accordance with para. 5.8.
- (2) Throughout Section 5,  $Re$ , of 2,300 is taken as a distinct separation between laminar and turbulent flow. Of course, a distinct separation does not exist. If  $Re$ , is found to be in the range of 2,000 to 10,000, the user may refer to Appendix D for a more rigorous treatment.
- (3) If the Reynolds numbers for both the design and test conditions do not fall in the same regime, the simple ratios above do not apply; in that situation, the user must refer to Appendix D.
- (4) For those cases in which the fluid in the test is in a single phase throughout the system, temperature and velocity variations between design and test conditions will be the only parameters affecting the pressure drop measurements. If the fluid is a liquid, the variations in temperature will usually cause only slight variations in density and, in general, density may be neglected in the above equations. The viscosity may or may not change significantly, depending on the fluid and temperature ranges involved. If the viscosity or friction factor varies by a factor of two or more from inlet to outlet, pressure drop must be evaluated on an incremental basis. The formulas presented above presume pressure drop variations through the tubes are representative of pressure drop variations through all components between pressure measuring stations. If this is not believed to be the case, a more detailed evaluation of variations in pressure drop through individual components of the heat exchanger may be desirable.

**5.9.3 Adjustment of Overall Heat Transfer Coefficient.** To adjust measured overall heat transfer coefficients to the design conditions, adjustments may be necessary to compensate for the following:

- (a) process fluids with properties or conditions other than design
- (b) process flow rates other than design
- (c) air flow rates other than design
- (d) air at conditions other than design

Adjustments for commonly encountered applications without phase change or change in flow regime may be made using the procedure outlined below. Adjustments for other less-frequently encountered situations can be made using the relationships in Appendix D. Particular care should be taken to assure results obtained with the equipment and test under consideration are appropriate for analysis by the equations proposed. The user must recognize that accuracy will suffer if adjustments are made from conditions which vary significantly from design. See paras. 3.14 and 3.15 for limitations.

In general, the approach presented is to calculate the overall heat transfer coefficient from the test results, break this coefficient into its component parts, adjust those component coefficients which change

from test conditions to design conditions, and finally recombine the component coefficients to calculate an adjusted overall heat transfer coefficient.

Agreement must be reached prior to testing regarding use of the adjustment procedure presented below or an alternate.

## STEP 1

Determine the overall reference surface heat transfer coefficient as indicated by the test result.

$$U_r^\circ = Q^\circ / (A_r \times \text{EMTD}^\circ) \quad (5.14)$$

See para. 5.4 for development of  $Q^\circ$  and para. 5.5 for development of  $\text{EMTD}^\circ$ .

## STEP 2

The test overall reference surface heat transfer coefficient must be broken down into its component parts. The following equation represents the normal heat transfer resistances which may be encountered.

$$\frac{1}{U_r^\circ} = \left( \frac{1}{h_i^\circ} \right) \left( \frac{A_r}{A_{p_i}} \right) + R_{f_i} \left( \frac{A_r}{A_{p_i}} \right) + \frac{A_r \ln(r_{p_o} / r_{p_i})}{2\pi L N k_{p_w}} + \left( \frac{1}{h_b} \right) \left( \frac{A_r}{A_{p_o}} \right) + A_r \left( \frac{\ln(r_{r_o} / r_{r_i})}{2\pi L N k_r} \right) + \left( \frac{A_r}{A_o} \right) \left( \frac{1}{h_o \left[ \frac{A_{f_m}}{A_o} (\phi_{f_m}^\circ - 1) + 1 \right]} \right) + R_{f_o} \left( \frac{A_r}{A_o} \right) \quad (5.35)$$

*Inside (process fluid) Film*
*Inside Fouling*
*Prime Wall*
*Bond*
*Fin Root Wall*
*Fin and Air Film*
*Outside Fouling*

The values of all the individual components which comprise the right side of this equation must be determined. Some may be calculated directly by available correlations, some must be assumed and agreed upon by the parties to the test as discussed below, and the final factor (either the air-side or process-side film coefficient) will be determined in Step 3 by solving the above equation.

The decision as to whether the air- or process-side film coefficient is calculated directly should be made on the basis of which can be determined more accurately. In cases where it is uncertain which coefficient may be determined with greater confidence, it may be agreed to calculate both and use the coefficient showing the lower thermal resistance to solve for the other in Step 3.

A discussion of how each component may be determined follows.

**Inside (Process Fluid) Film:**

If the process fluid is a liquid in turbulent flow in a plain tube (no internal enhancement), the value of  $h_i^\circ$  may be evaluated using the Sieder-Tate equation (Ref. [4]):

$$h_i^\circ = 0.023 \left( \frac{k_p^\circ}{D_{r_i}^\circ} \right) \left( \frac{V_p^\circ D_{r_i}^\circ \rho_p^\circ}{\mu_p^\circ} \right)^{0.8} \times \left( \frac{\mu_p^\circ c_{p_p}^\circ}{k_p^\circ} \right)^{0.33} \left( \frac{\mu_p^\circ}{\mu_{p_w}^\circ} \right)^{0.14} \quad (5.36)$$

In cases of gaseous process fluids:

$$h_i^\circ = 0.023 \frac{k_p^\circ}{D_{r_i}^\circ} \left( \frac{V_p^\circ D_{r_i}^\circ \rho_p^\circ}{\mu_p^\circ} \right)^{0.8} \times \left( \frac{\mu_p^\circ c_{p_p}^\circ}{k_p^\circ} \right)^{0.33} \quad (5.37)$$

The physical properties in the above equations are evaluated at the average fluid temperature except  $\mu_{p_w}^\circ$  which is evaluated at the surface temperature. If the process fluid is water, Figs. D.2a and D.2b of Appendix D may be used to evaluate  $h_i^\circ$ .

NOTE: The above formulas are applicable for non-condensing situations with the process fluid in turbulent flow ( $Re_i > 10,000$ ). For cases in which  $Re_i$  is below 10,000, refer to Appendix D.

**Inside Fouling:**

Of the component resistances, fouling is the most difficult to determine. There is no practical way to

determine fouling resistance during equipment testing. Fouling resistances shall be agreed on as stated in para. 3.2.

Refer to Appendix E for additional discussion of fouling.

**Prime Wall:**

This resistance is calculated directly using the applicable part of Eq. (5.35).

**Bond:**

The value of the bond resistance,  $l/h_b$ , will depend upon the type of extended surface being used, the tube and fin materials, the temperature level of application, and the manufacturing practice. In many cases, the value of this component will be low in comparison with other terms, making it insignificant. If this is thought not to be the case, it is suggested that the manufacturer's design value for this term be used in the calculation. However, mutual agreement on this matter must be reached by the parties to the test.

**Fin Root Wall:**

The value of this component will be small in comparison with other terms, making it insignificant in most cases. This resistance is calculated by the basic relationship shown in Eq. (5.35). Depending on the details of fin construction, assessment of the outside radius of the fin root wall ( $r_{r_o}$ ) may require considerable judgment.

**Fin and Air Film:**

This term must be evaluated by first determining the air-side film coefficient. An exact evaluation of this coefficient is difficult to develop due to the complex shape of the heat transfer surface involved. It may be agreed by the parties to use the manufacturer's proprietary data to develop this coefficient. If not, it is suggested that the following equation (Ref. [5]) for finned banks of tubes be used as a reasonable approximation:

$$h_o^\circ = 0.134 \left( \frac{k_a^\circ}{D_{r_o}^\circ} \right) \left( \frac{D_{r_o}^\circ C_{p_a}^\circ}{\mu_a^\circ} \right)^{0.681} \left( \frac{c_{p_a}^\circ \mu_a^\circ}{k_a^\circ} \right)^{0.33} \left( \frac{s}{l} \right)^{0.2} \left( \frac{s}{f_l} \right)^{0.1134} (F_r) \quad (5.38)$$

NOTES:

(1)  $G_{max}^o$  is the mass flow rate evaluated with respect to the free flow area.

(2) Equation (5.38) is applicable for Re from 1000 to 20,000, where

$$Re_a = \frac{D_p^o G_{max}^o}{\mu_a^o} = \frac{D_{pa}^o \rho_a^o V_{max}^o}{\mu_a^o}$$

(3)  $F_r$  is tube row arrangement factor; values are given in Table 5.1.

Once the film coefficient is evaluated, it may then be used in the determination of the fin efficiency  $\phi_{fn}^o$ . Figures 5.10 through 5.13 may be used in this evaluation. Symbols in these figures are defined below:

- $h$  = heat transfer coefficient
- $l$  = modified Bessel function of the first kind
- $K$  = modified Bessel function of the second kind
- $k$  = thermal conductivity of fin material
- $n$  = a constant, order of Bessel function
- $u$  = function of  $x$  defined by

$$u = -icx^p = x \sqrt{\frac{h dA}{k_s dx}}$$

where  $i = \sqrt{-1}$ ;  $c$  = a constant;  $p$  = a constant;  $a$  = cross-sectional area of fin normal to  $x$  axis, and  $A$  = fin surface between origin and point  $x$ .

- $w$  = fin height
- $x$  = distance along axis normal to basic surface
- $y$  = half thickness of fin at point  $x$
- $\alpha, \beta$  = constants
- $b, e$  = conditions at base and edge, respectively

For additional discussion of fin efficiencies and numerical relationships for calculation of the efficiencies, the parties may refer to Ref. [7].

With the values of  $\phi_{fn}^o$  and  $h_o^o$  established, the equivalent convective and conductive resistance of the fin may be calculated using the relationship given in Eq. (5.35). The user must be cautioned that the method presented above is approximate and does not address all types of fin configurations and tube arrangements.

**Outside Fouling:**

This resistance, like *Inside Fouling*, is difficult to determine. The provisions of para. 3.7(b) shall be followed, and a value agreed on prior to the test, as stated in para. 3.2.

**TABLE 5.1**  
**VALUES OF  $F_r$  FOR EQ. (5.38)**

No. of Tube Row Deep	Tube Row Arrangement Factor, $F_r$
1	0.78
2	0.88
3	0.93
4	0.97
5	0.98
6	1.00
8	1.02
10	1.025

GENERAL NOTES:

- (a) These factors are applicable for the normal staggered tube arrangement.
- (b) Values in this table are calculated from Fig. 11 of Ref. [6], using  $V_{max} = 1000$  feet per minute and using the value for 6 rows as a base, since Eq. (5.38) is based on 6 rows.

**STEP 3**

Solve for the component resistance not determined by the correlations by subtracting the sum of the evaluated component resistances from the overall heat transfer resistance.

**STEP 4**

The components on the right-hand side of Eq. (5.35) must be adjusted to design conditions. The only components which will be affected by these adjustments are the inside film resistance and equivalent convection and conduction resistance of the fins. The adjustments may be made as follows:

**Inside (Process Fluid) Film:**

The Sieder-Tate relationship may be used to ratio turbulent test and adjusted design coefficients

$$h_i^* = h_i^o \left( \frac{k_p^*}{k_p^o} \right) \left( \frac{V_p^* \rho_p^* \mu_p^o}{V_p^o \rho_p^o \mu_p^*} \right)^{0.8} \times \left( \frac{\mu_p^* c_{p,p}^* k_p^o}{\mu_p^o c_{p,p}^o k_p^*} \right)^{0.33} \left( \frac{\mu_p^* \mu_{p,w}^o}{\mu_p^o \mu_{p,w}^*} \right)^{0.14} \quad (5.39)$$

The physical properties in the above equation are evaluated at the average fluid temperature except  $\mu_{p,w}^*$  which is evaluated at the surface temperature.

NOTE: The above equation is applicable for non-condensing situations with the process fluid in turbulent flow ( $Re > 10,000$ ).

**Fin and Air Film:**

Equation (5.40) may be used to yield an approximate ratio of test and adjusted design film coefficients

$$h_o^+ = h_o^{\circ} \left( \frac{k_a^*}{k_a^{\circ}} \right)^{0.66} \left( \frac{W^* \mu_a^{\circ}}{W^{\circ} \mu_a^*} \right)^{0.661} \quad (5.40)$$

NOTE: The above equation is applicable for Re from 1000 to 20,000, where

$$Re_a = \frac{D_p^{\circ} C_{p_{\max}}^{\circ}}{\mu_a^{\circ}} = \frac{D_p^{\circ} \rho_a^{\circ} V_{\max}^{\circ}}{\mu_a^{\circ}}$$

If the film coefficient is not greatly changed in the above adjustment, accuracy will not be substantially reduced if it is assumed that the entire equivalent convection and conduction resistance of the fin varies as the film coefficient. If greater accuracy is desired, the fin efficiency may be determined for both test and design conditions using Figs. 5.10 through 5.13 as applicable.

**STEP 5**

The adjusted inside film resistance and equivalent convection and conduction resistance of the fin must be substituted into Eq. (5.35) to determine the adjusted overall heat transfer coefficient  $U_r^+$  for the equipment.

**5.9.4 Computation of Capability.** Thermal performance capability, as defined in this Code, is the ratio of test capacity to design capacity, where test capacity is the actual flow rate of process fluid the ACHE will handle at design conditions of the following:

- process fluid composition
- process fluid inlet and outlet temperatures
- process fluid inlet pressure
- air inlet temperature and density
- fan power

The determination of this flow rate, as stated in para. 5.1, is an iterative one, since the corresponding

heat load, process flow rate, inside film resistance, and EMTD are all unknown.

The recommended procedure for determination of capability is:

- Assume a value of process fluid flow rate,  $W^+$ .
- Compute corresponding heat load from Eq. (5.6) or (5.7), as appropriate.
- Adjust the test air flow rate to design fan power and air density:

$$w^+ = w^{\circ} \left( \frac{HP^*}{HP^{\circ}} \right)^{1/2.7} \left( \frac{\rho_a^*}{\rho_a^{\circ}} \right)^{2/3}$$

- Compute  $t_2^+$  at design fan power from

$$t_2^+ = t_1^* + \frac{Q^+}{(c_p w^+)}$$

- Compute corresponding value of EMTD<sup>+</sup> (see para. 5.5).

- Adjust all test resistances, as necessary, to correspond to the assumed  $W^+$ , and compute  $U_r^+$ :

$$\text{TOTAL RESISTANCE } R_{\text{total}}^+ = R_1^+ + R_2^+ + R_3^+ \dots$$

$$U_r^+ = \frac{1}{R_{\text{total}}^+}$$

- Compute corresponding heat load from

$$Q^+ = (U_r^+) (A) (\text{EMTD}^+)$$

- Repeat steps (1) through (7) until values of  $Q^+$  from steps (2) and (7) are equal. Graphical or computer assistance may be helpful in this iterative solution of  $W^+$ .

- Compute thermal performance capability:

$$\text{PERCENT CAPABILITY} = \left( \frac{W^+}{W^*} \right) \times 100$$

$$R = \frac{T_1 - T_2}{t_2 - t_1}$$

*T* and *t* are *not* interchangeable

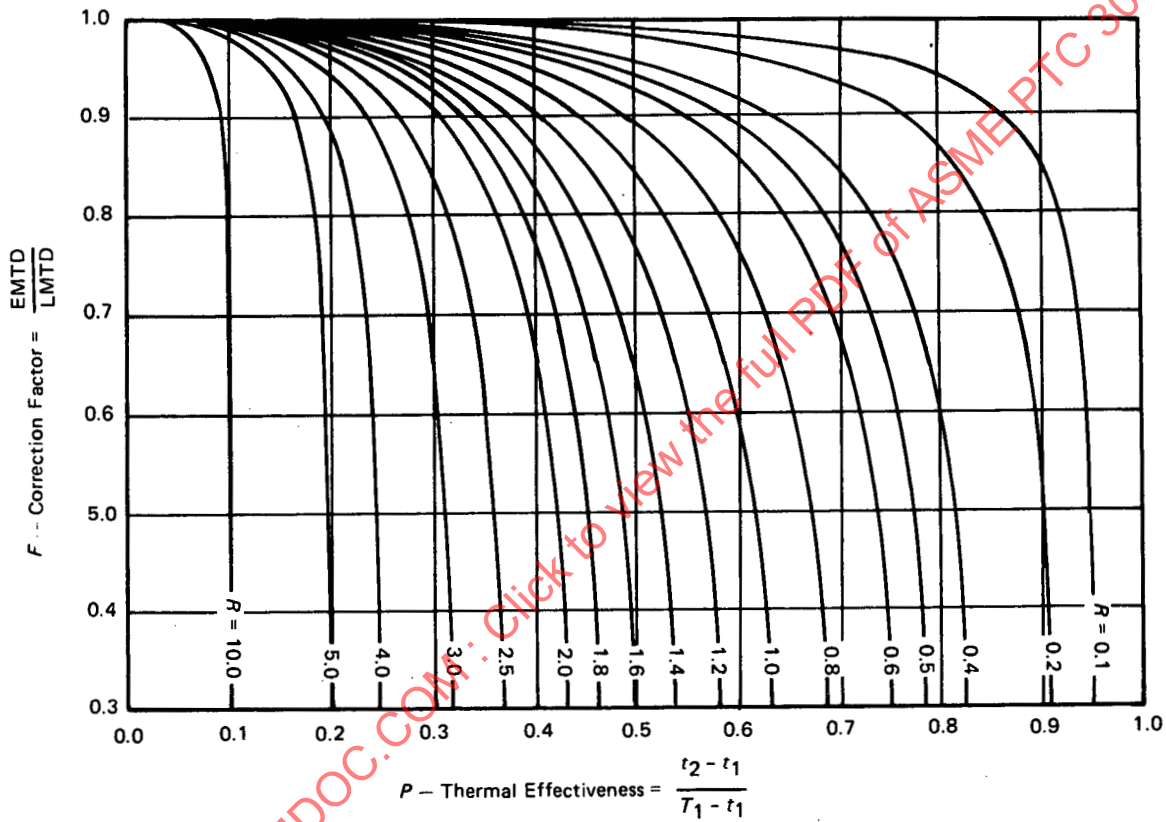
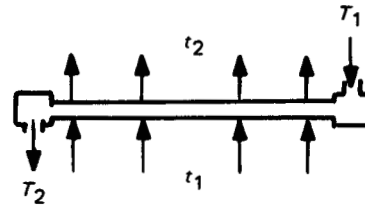

**FIG. 5.1 MEAN TEMPERATURE DIFFERENCE RELATIONSHIPS**  
**Crossflow Unit – 1 Tube Row, Unmixed**  
 (Reproduced by permission of Heat Transfer Research, Inc.)

$$R = \frac{T_1 - T_2}{t_2 - t_1}$$

*T* and *t* are *not* interchangeable

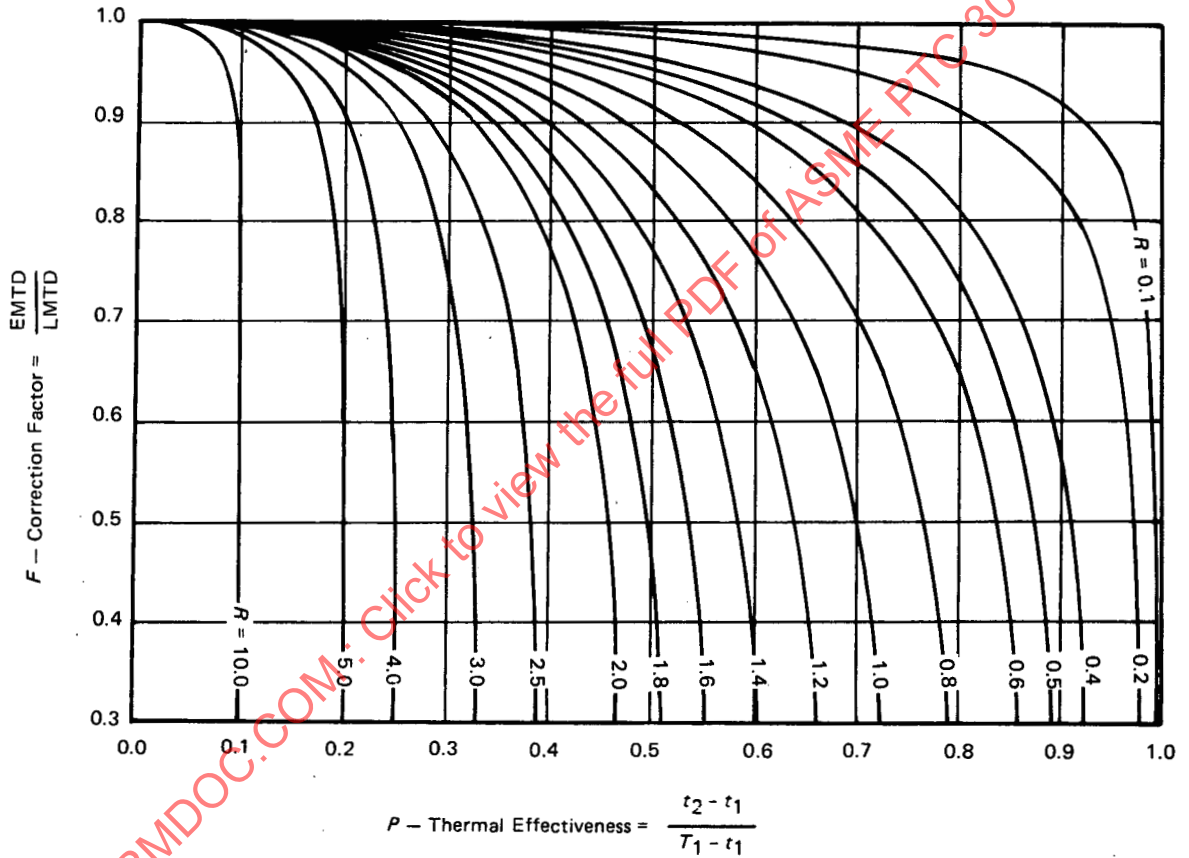
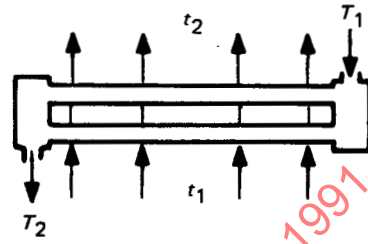
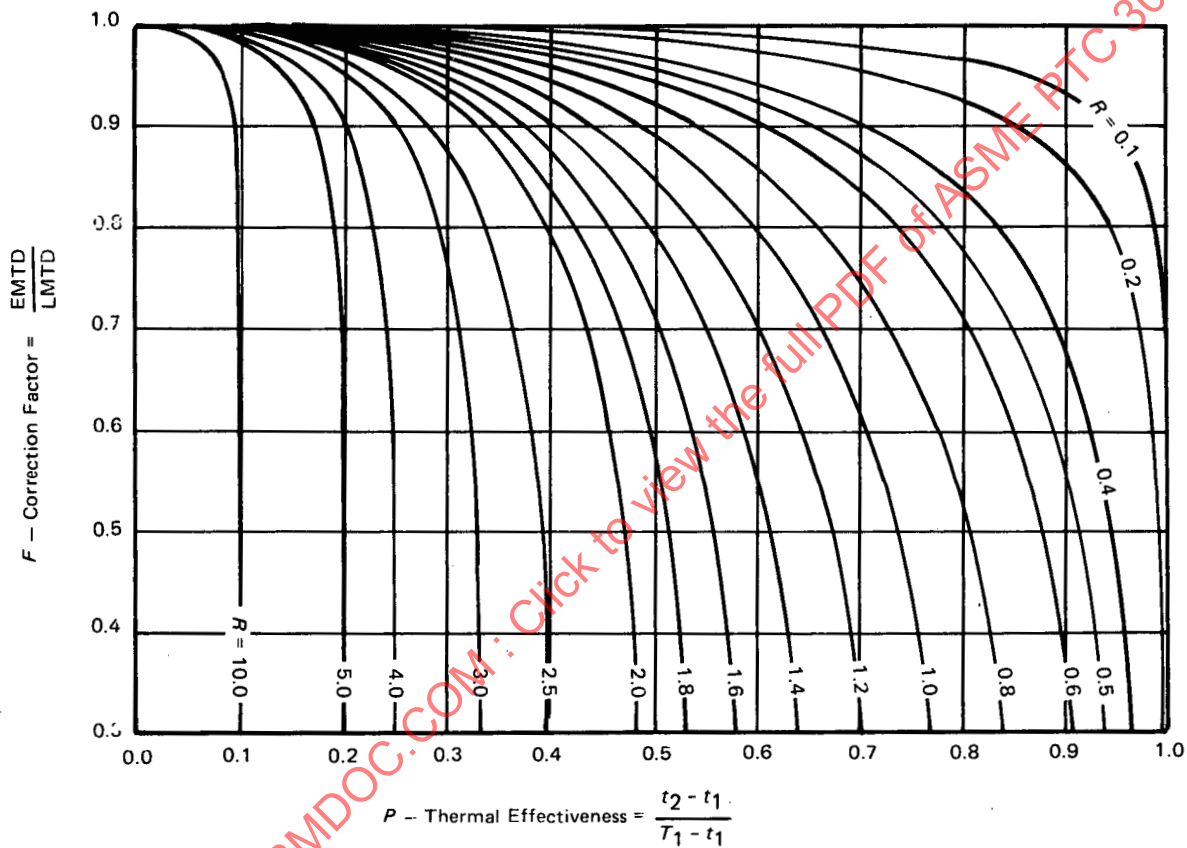
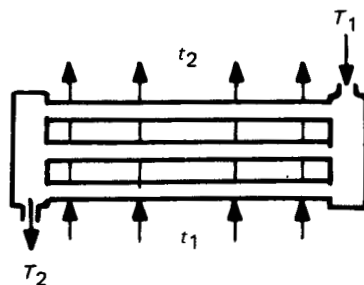

**FIG. 5.2 MEAN TEMPERATURE DIFFERENCE RELATIONSHIPS**  
**Crossflow Unit – 2 Tube Rows, 1 Pass, Unmixed**  
 (Reproduced by permission of Heat Transfer Research, Inc.)



$$R = \frac{T_1 - T_2}{t_2 - t_1}$$

*T* and *t* are *not* interchangeable



**FIG. 5.3 MEAN TEMPERATURE DIFFERENCE RELATIONSHIPS**  
 Crossflow Unit – 3 Tube Rows, 1 Pass, Unmixed  
 (Reproduced by permission of Heat Transfer Research, Inc.)

$$R = \frac{T_1 - T_2}{t_2 - t_1}$$

*T* and *t* are *not* interchangeable

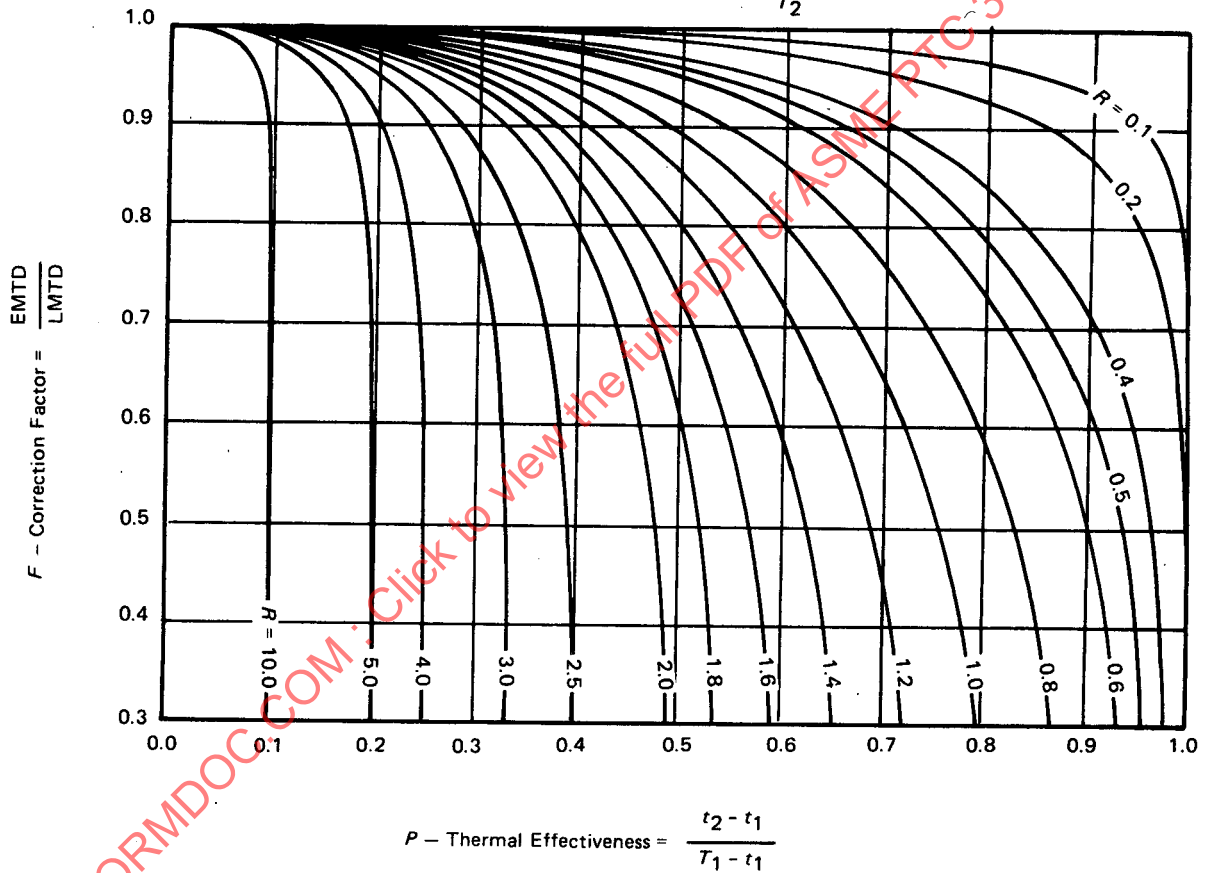
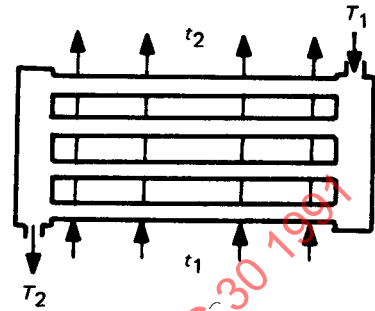
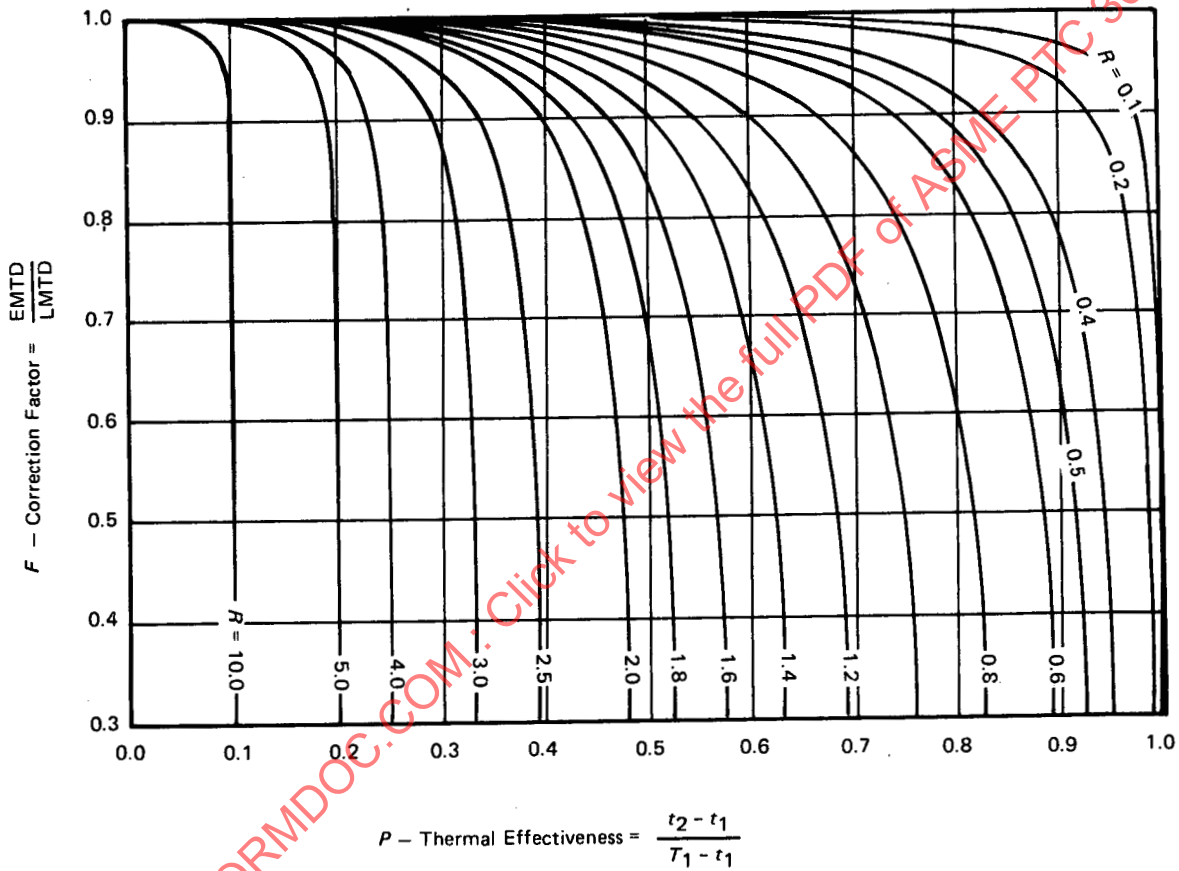
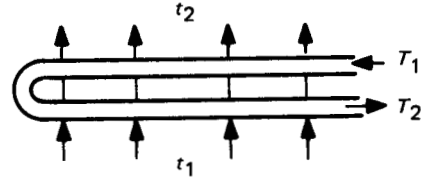

**FIG. 5.4 MEAN TEMPERATURE DIFFERENCE RELATIONSHIPS**  
 Crossflow Unit – 4 Tube Rows, 1 Pass, Unmixed  
 (Reproduced by permission of Heat Transfer Research, Inc.)



$$R = \frac{T_1 - T_2}{t_2 - t_1}$$

*T* and *t* are *not* interchangeable



**FIG. 5.5 MEAN TEMPERATURE DIFFERENCE RELATIONSHIPS**  
**Crossflow Unit – 2 Tube Rows, 2 Passes, Unmixed Between Passes**  
 (Reproduced by permission of Heat Transfer Research, Inc.)

$$R = \frac{T_1 - T_2}{t_2 - t_1}$$

*T and t are not interchangeable*

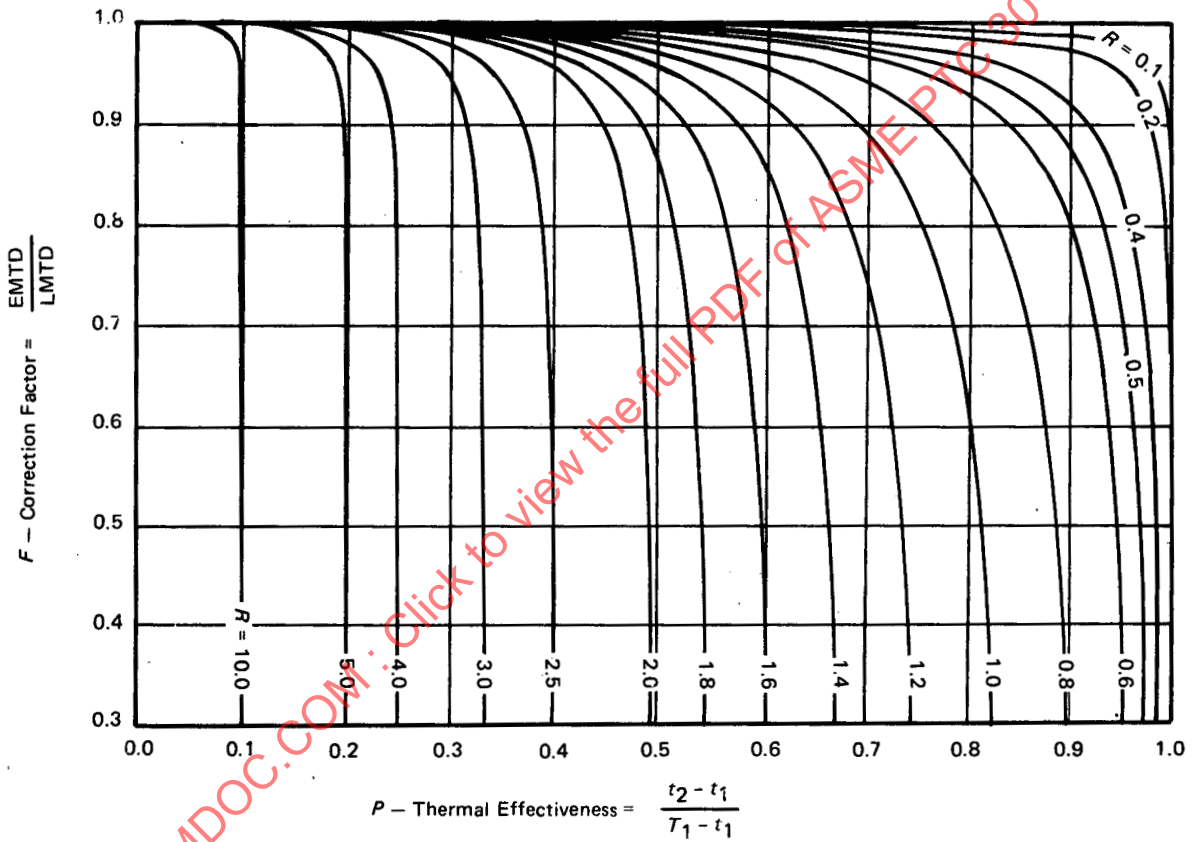
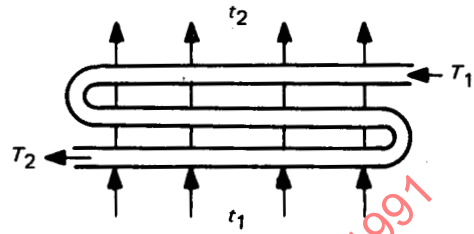

**FIG. 5.6 MEAN TEMPERATURE DIFFERENCE RELATIONSHIPS**  
**Crossflow Unit – 3 Tube Rows, 3 Passes, Unmixed Between Passes**  
 (Reproduced by permission of Heat Transfer Research, Inc.)

$$R = \frac{T_1 - T_2}{t_2 - t_1}$$

*T* and *t* are *not* interchangeable

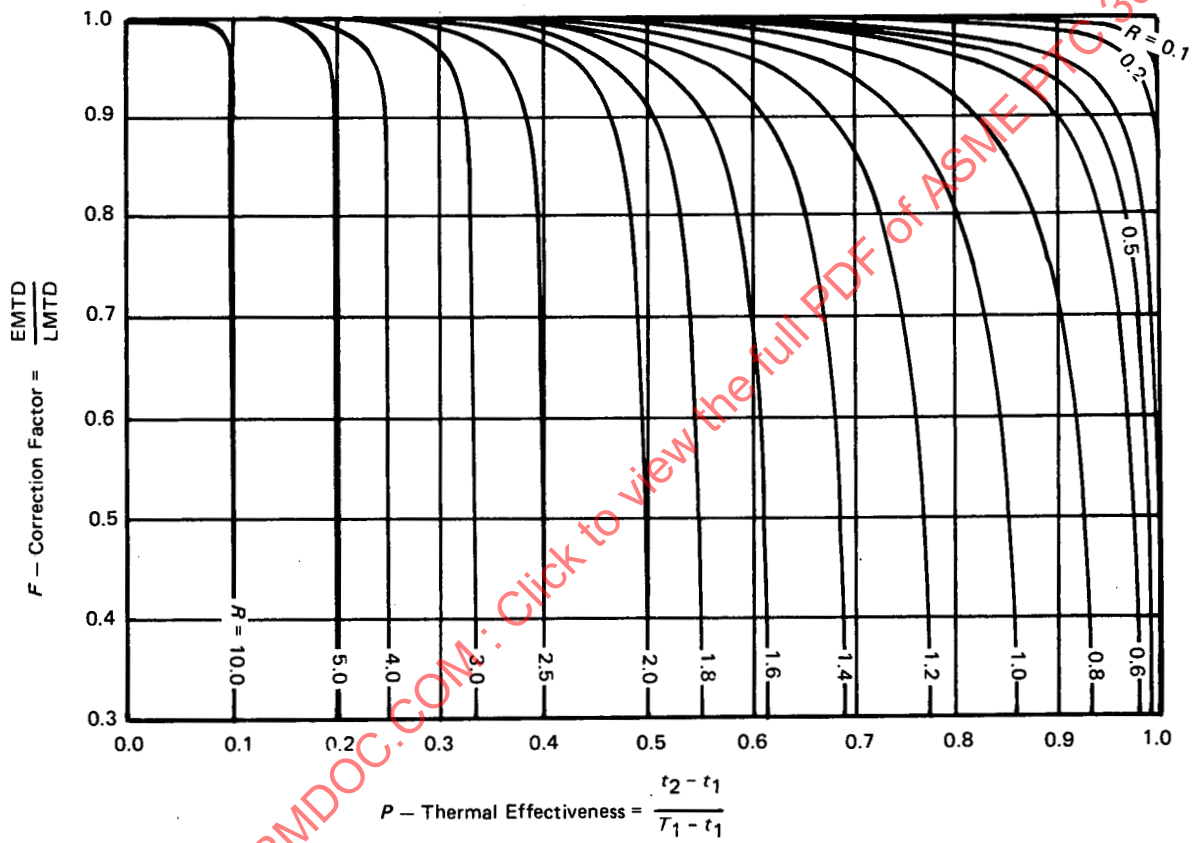
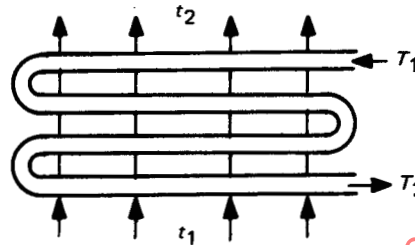

**FIG. 5.7 MEAN TEMPERATURE DIFFERENCE RELATIONSHIPS**  
 Crossflow Unit – 4 Tube Rows, 4 Passes, Unmixed Between Passes  
 (Reproduced by permission of Heat Transfer Research, Inc.)

$$R = \frac{T_1 - T_2}{t_2 - t_1}$$

*T* and *t* are *not* interchangeable

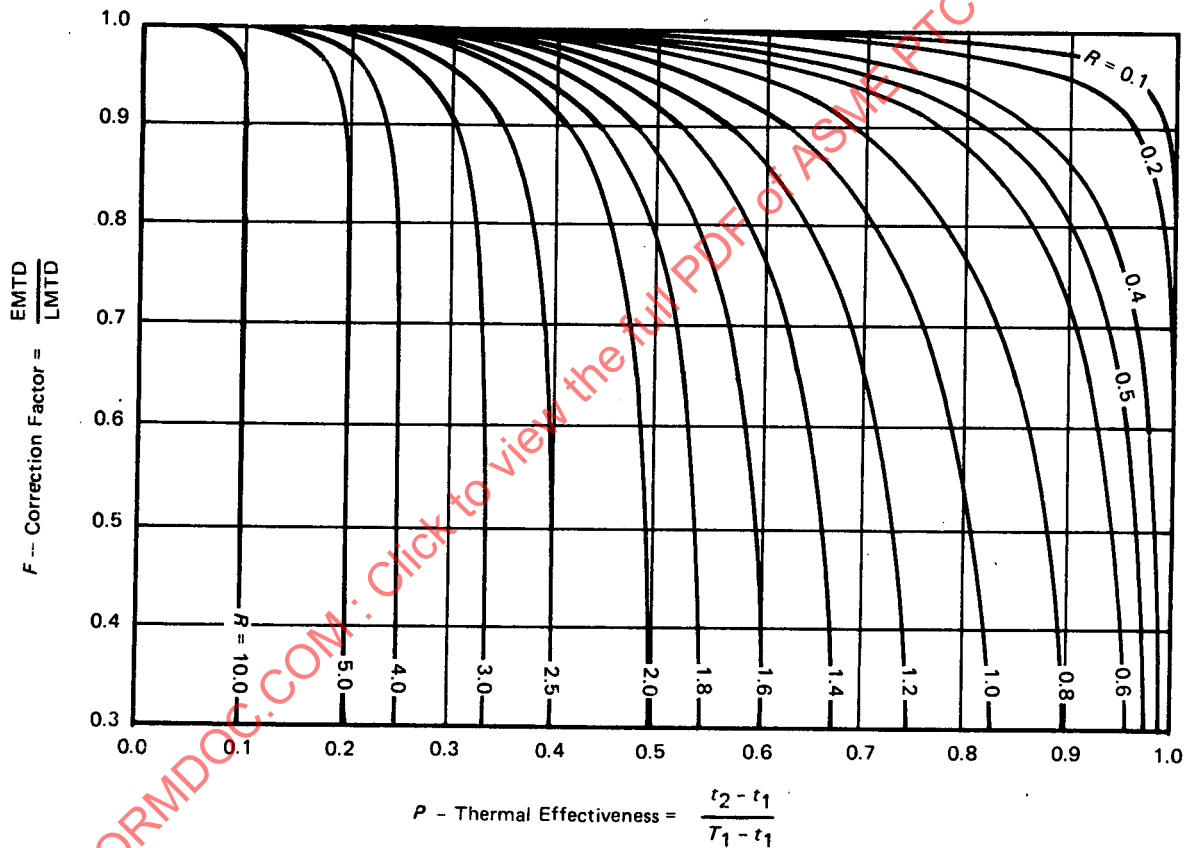
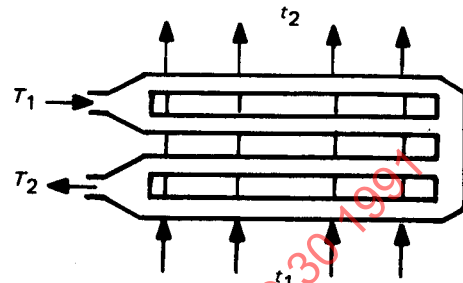

**FIG. 5.8 MEAN TEMPERATURE DIFFERENCE RELATIONSHIPS**  
 Crossflow Unit — 4 Tube Rows in 2 Passes, 2 Tube Rows Per Pass, Mixed at the Header  
 (Reproduced by permission of Heat Transfer Research, Inc.)

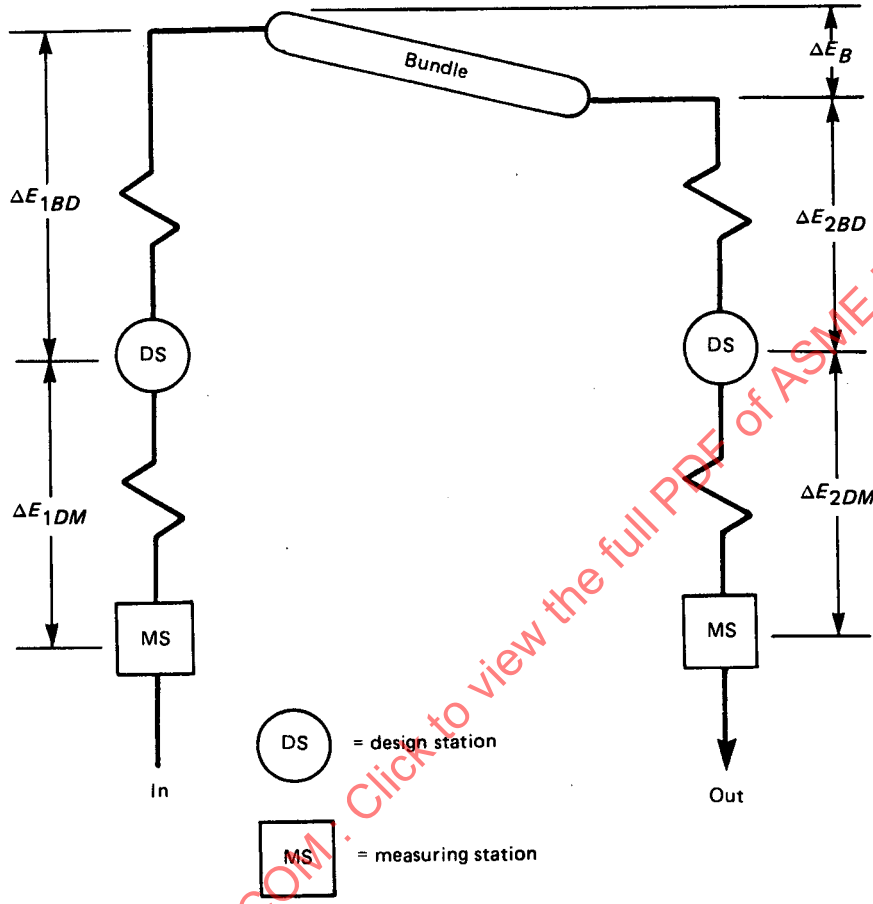

FIG. 5.9 SCHEMATIC OF PROCESS FLUID PIPING

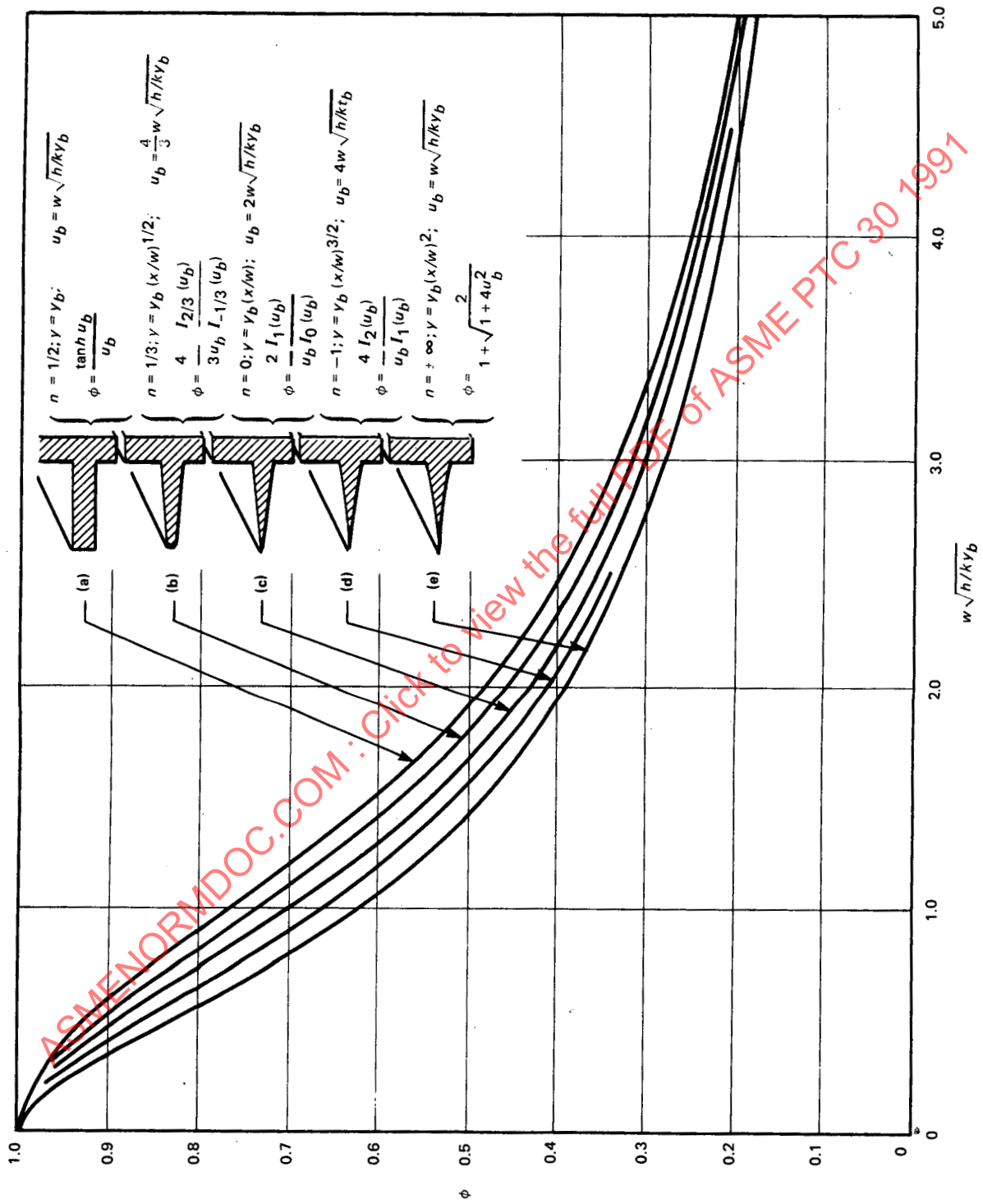

FIG. 5.10 FIN EFFICIENCY OF SEVERAL TYPES OF STRAIGHT FINS

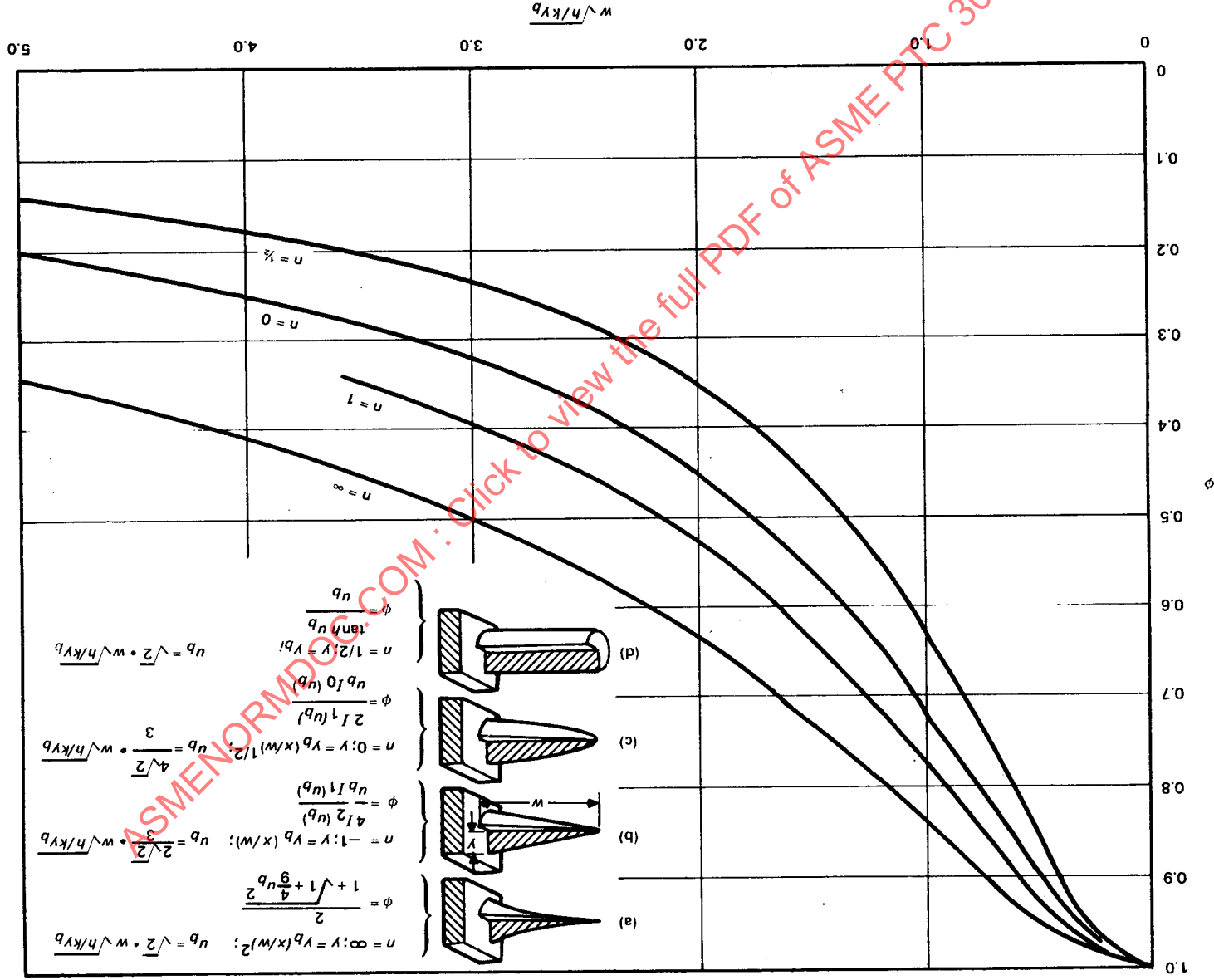

FIG. 5.11 EFFICIENCY CURVES FOR FOUR TYPES OF SPINE FINS



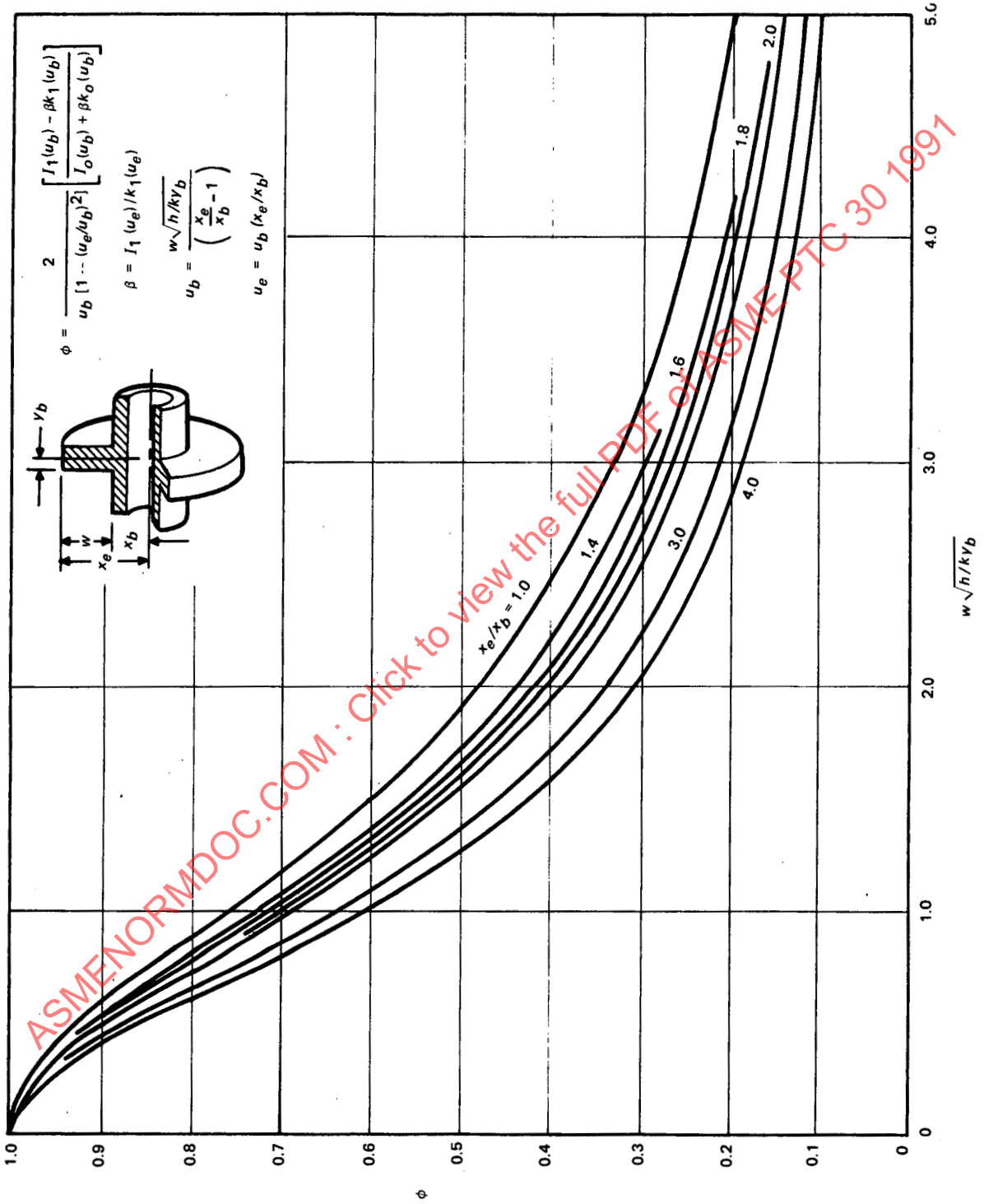

FIG. 5.12 EFFICIENCY OF ANNULAR FINS OF CONSTANT THICKNESS

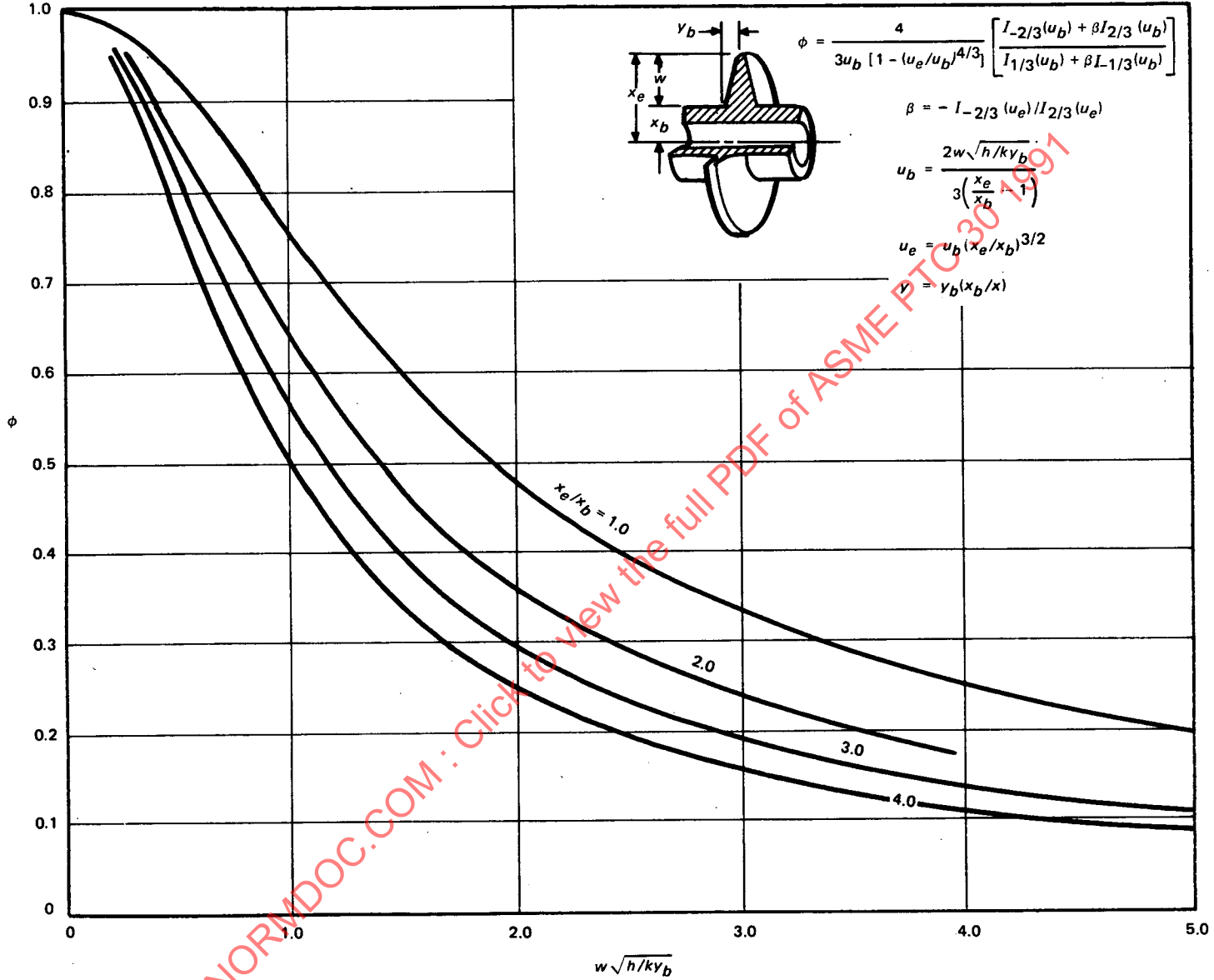

FIG. 5.13 EFFICIENCY OF ANNULAR FINNS WITH CONSTANT METAL AREA FOR HEAT FLOW

45

ASMENORMDOC.COM : Click to view the full PDF of ASME PTC 30-1991

INTENTIONALLY LEFT BLANK

ASMENORMDOC.COM : Click to view the full PDF of ASME PTC 30 1997

## SECTION 6 – REPORT OF RESULTS

### 6.1 COMPOSITION OF REPORT

The test report for a performance test shall include the following.

#### 6.1.1 General Information

- (a) Identification of the equipment to be tested
- (b) Identification of the plant where the equipment is located
- (c) The name of the owner of the equipment and his representative at the test
- (d) The name of the manufacturer and his representative at the test
- (e) A statement of who conducted the test
- (f) Date of the test
- (g) Date of first commercial operation of the equipment
- (h) The design rating and specified operating conditions for the equipment
- (i) A statement of the guarantee

**6.1.2 Object of the Test.** This shall tell why the test is being run and what the parties to the test are trying to accomplish.

**6.1.3 Discussion.** This shall include a brief history of the operation of the equipment and any pertinent background information. It shall list all prior agreements made with regard to the test.

It shall also discuss any inspection prior to or following the test and state what was inspected and what was found. It shall describe when and how the unit was last cleaned and its condition during the test. This shall include a description of any fouling.

**6.1.4 Test Methods and Procedures.** This shall describe how the test was actually conducted including any unusual occurrences during the test.

It shall include a statement that the test was conducted in accordance with ASME PTC 30, including a list of exceptions, if any.

**6.1.5 Test Data and Results at Operating Conditions.** This shall include a listing of the reduced data for each run after all corrections are applied. It shall also list a summary of the results at operating conditions.

**6.1.6 Test Result Adjusted to Design Conditions.** This shall list the adjusted test results (adjusted to design conditions) and compare those results to the specified performance at design conditions.

**6.1.7 Conclusions.** This shall be a statement of the conclusions derived from the test, including whether or not the equipment met its design performance and the extent to which it exceeded it or fell short.

**6.1.8 Uncertainty Analysis.** The report shall include the uncertainty analyses (in accordance with paras. 3.4 and 3.17) for each run.

**6.1.9 Appendices.** As a minimum the following Appendices shall be included.

(a) **Sample Calculation** – This shall be included using the data from one run. It shall illustrate all the calculations and adjustments that are made to that run so that a reader could start with the data from any run and make all necessary calculations to verify the results of any of the other runs.

(b) **Layout Sketches** – This shall include adequately dimensioned sketches, both plan and elevation views, showing the location of the equipment and its relationship to any other equipment or buildings in the vicinity that would affect air flow. It should also show wind speed and direction for each run.

(c) List of Instrumentation — This shall list all the instrumentation used on the test, including manufacturer and model number.

(d) List of all participating personnel.

(e) Uncertainty Analysis Sample Calculation — A sample calculation for one run should be included. It should use the same run that was used for the results sample calculation, per (a) above.

**6.1.10 Raw Data Distribution.** At least one complete set of copies of the signed original log sheets shall be distributed to each party in the test.

## 6.2 REPORT DATA

As stated in para. 6.1.5 the reduced test data for each run with all corrections applied should be listed in the report. A list of typical data follows. Since there are many types of air cooled heat exchangers, this list is not necessarily comprehensive but can be used as a guide. Any other data that is pertinent to the test should also be included.

### 6.2.1 General Information

- (a) Run number
- (b) Date
- (c) Barometric pressure — in. Hg
- (d) Ambient dry-bulb temperature — °F
- (e) Ambient wet-bulb temperature — °F
- (f) Wind speed — mph
- (g) Wind direction

### 6.2.2 Air-Side Temperatures

- (a) Inlet dry-bulb temperature — °F
- (b) Inlet wet-bulb temperature — °F
- (c) Outlet dry-bulb temperature — °F

### 6.2.3 Air Densities

- (a) Ambient air density — lbm/ft<sup>3</sup>
- (b) Inlet air density — lbm/ft<sup>3</sup>
- (c) Outlet air density — lbm/ft<sup>3</sup>

### 6.2.4 Air Flow

- (a) Total inlet air flow — ACFM — ft<sup>3</sup>/min
- (b) Total outlet air flow — ACFM — ft<sup>3</sup>/min
- (c) Total air flow — SCFM — ft<sup>3</sup>/min
- (d) Total air flow — lbm/hr

### 6.2.5 Process-Side Conditions

- (a) Inlet process temperature — °F
- (b) Outlet process temperature — °F
- (c) Inlet process pressure — lbf/ft<sup>2</sup>
- (d) Process pressure drop across ACHE — lbf/ft<sup>2</sup>
- (e) Process flow — lbm/hr

### 6.2.6 Miscellaneous

- (a) Heat load — air-side — Btu/hr
- (b) Heat load — process-side — Btu/hr
- (c) Fan driver power input per fan — hp
- (d) Total fan driver power input — hp
- (e) Uncorrected mean temperature difference — °F
- (f) Mean temperature difference correction factor — °F
- (g) Effective mean temperature difference — °F
- (h) Adjusted overall heat transfer coefficient — Btu/hr·ft<sup>2</sup>·°F
- (i) Adjusted process fluid flow rate — lbm/hr
- (j) Adjusted heat load — Btu/hr
- (k) Capability — %

## APPENDIX A – TESTING GUIDELINES

**A.1** The actual testing environmental conditions, the physical condition of the air cooled heat exchanger, and the process fluid operating conditions will decide whether or not a test will be considered valid. In order to enhance the probability of a successful test, a careful review and inspection should be conducted before starting a full-fledged test.

**A.2** All parties to the test must have a clear understanding and agreement of the proposed procedure, instrumentation, and meaningful results to be obtained. By prior agreement or through discussion at the site, one person, or a team consisting of one person from each of the various interests, must be put in responsible charge of the test and subsequent calculations and results. As a first action, it is suggested that Section 3, Guiding Principles, be reviewed so that disagreements, if any, can be resolved before testing.

**A.3** Plant operating personnel involved with the air cooled heat exchanger should be requested to report on performance daily. Ask about maintenance procedures, on-stream performance characteristics, process upsets, mechanical problems, and any clues concerning heat transfer performance.

**A.4** A brief preliminary check of the operating process flow and temperature conditions and air-side temperatures will help determine if the heat transfer and pressure drop are reasonably close to expectations. Also, this may point to areas requiring special attention during the equipment inspection before formal testing.

**A.5** The process fluid should be sampled and tested to ensure that all of its physical and transport properties are within acceptable limits.

**A.6** The physical inspection of the tube bundle should include checking for loose fins, intermeshed tubes, bowed tubes, and fouled or dirty air-side surface. Some of these may have resulted from cyclic operation, process overheating, rainstorm thermal shock, water spray cooling, or improper design for thermal growth or internal steamout. Defects such as these will affect performance and should be noted in the test report.

**A.7** Check all fan assemblies for uniform blade pitch, blade leading edge forward, and clean and uncorroded airfoil surfaces. A change in air foil shape will likely decrease fan efficiency. Prevent automatically variable pitch blades from modulating during the test.

**A.8** Insure that air seals, baffles, tip seals, etc., as originally designed are in place to avoid unexpected air leakage.

**A.9** Observe the exchanger in operation, keeping alert to hot air currents from outside sources or discharge air recirculation. By agreement, eliminate these to the maximum extent possible.

**A.10** All test personnel should observe the maximum safety precautions while taking data. Each person must stay within his assigned station to avoid interference or possibly dangerous disruption to other test personnel. Become acquainted with safety facilities, escape routes, and alarm systems before undertaking the test. Be alert to possible physical harm from hot process streams and discharge air. Insure that all required safety and protective devices, such as fan and belt guards, are properly installed.

**A.11** Steady-state conditions are desirable for the most meaningful test results. If test personnel ob-



serve transient test data, they should alert the test leader who should decide if testing should continue, be stopped, or extended past the agreed-upon time.

**A.12** Interchange of agreed-upon instrumentation during the test is a good technique to account for individual instrument error, or to flag significant errors. This is particularly applicable to the measurement of process fluid temperature and pressure at the exchanger inlet and outlet.

**A.13** If process flow and heat load are inadequate to properly load all of the exchanger bays, it may be possible to divert the flow by valves to a fewer number of bays so that the flow rate and the heat load per bay are closer to the design point. If this technique is agreed upon, the fans on inactive bays

should be kept running in order to maintain the full unit air flow patterns. Potential uneven distribution of flow of the process fluids must be considered, particularly if the process is a two-phase system. This technique must also result in the inside-tube flow regime being similar to the original design, i.e., laminar or turbulent, the same predicted mechanism of condensation, etc. Testing in the transition zone between laminar and turbulent flow will not be reliable.

**A.14** Normally a performance test is run as soon as possible after cleaning. However, if there is doubt about the internal fouling resistance, it may be possible to "shock" clean certain processes, while on stream, using water, steam, or solvent injection. This should be arranged in advance of the test so that the proper operations personnel are available if it appears necessary to investigate the effect of such cleaning.

ASMENORMDOC.COM : Click to view the full PDF of ASME PTC 30-1991

## APPENDIX B — EXAMPLE

This example is presented to illustrate a thermal performance test of an Air-Cooled Heat Exchanger (ACHE). Due to the large variety of designs and applications covered by the Code, this example is by no means comprehensive. The sample specifications, contract provisions, data sheets, data, and calculations are not for general application, but may be helpful in formulating similar test procedures for other ACHE designs and applications.

### B.1 INQUIRY

An inquiry was issued to manufacturers to quote an ACHE for engine jacket-water cooling:

- Fluid to be cooled — clean water
- Circulation rate, lbm/hr — 285,000
- Inlet temperature, °F — 168.0
- Outlet temperature, °F — 149.0
- Heat load, Btu/hr — 5,415,000
- Inlet pressure, psig — 60
- Maximum allowable pressure drop, psi — 8.0
- Ambient air temperature, °F — 94.0
- Fouling resistance, hr·ft<sup>2</sup>·°F/Btu:
  - Internal (based on prime inside surface) — 0.0010
  - External (based on prime outside surface) — 0
- Site elevation — sea level
- Barometric pressure, in. Hg — 29.92

### B.2 SPECIFICATIONS

The following specifications submitted by the successful vendor were accepted and made part of the contract:

#### B.2.1 General

- (a) Type of unit — ACHE
- (b) Service — water cooling
- (c) Air flow mode — induced draft

#### B.2.2 Tube Bundle

- (a) Number per unit — 1
- (b) Nominal dimensions, width × tube length, ft — 10 × 24
- (c) Design pressure, psig — 100
- (d) Number of tube rows — 4
- (e) Total number of tubes — 192
- (f) Number of tube passes — 4
- (g) Number of tubes per pass — 48
- (h) Tube pitch, inches — 2.50 Δ
- (i) Total effective heat exchange surface, ft<sup>2</sup>:
  - (1) External surface of prime tubes — 1,206
  - (2) External surface of fins — 23,500
- (j) Tube description:
  - (1) Prime tube
    - (a) Material — Admiralty
    - (b) Shape — cylindrical
    - (c) OD, in. — 1.000
    - (d) ID, in. — 0.902
    - (e) BWG wall thickness — 18 AW
  - (2) Fins
    - (a) Material — Aluminum
    - (b) Type — Spiral, extruded
    - (c) Number per in. — 9
    - (d) Dimension — 2.40 in. OD
    - (e) Root wall ID, in. — 1.000
    - (f) Root wall OD, in. — 1.160

#### B.2.3 Mechanical Equipment

- (a) Fans
  - (1) Number per unit — 2
  - (2) Diameter, ft — 8
- (b) Gears
  - (1) Number per unit — 2
  - (2) Type — right angle spiral bevel
- (c) Drivers
  - (1) Number per unit — 2
  - (2) Type — electric motor
  - (3) Nominal size, HP — 15

### B.3 CONTRACT

Pertinent provisions of the contract concerning thermal testing were:

(a) The test shall be conducted within six months after the unit is first placed in service.

(b) Internal and external heat transfer surfaces shall be cleaned prior to the test.

(c) A tube-side fouling resistance of 0.001 hr-ft<sup>2</sup>-°F/Btu (based on external surface of prime tubes) shall be used. Fouling on the external surface of the fins shall be considered zero.

(d) Heat load from measured process-side data ( $Q_p^o$ ) shall be used for the test heat load. Heat load from measured air-side data ( $Q_a^o$ ) shall be compared to  $Q_p^o$ . If the difference between  $Q_p^o$  and  $Q_a^o$  is less than 10% of  $Q_p^o$ , the test shall be considered valid. For determination of EMTD, the process-side data and the measured inlet air temperature shall be used. The test values of air flow rate and/or exit air temperature shall be adjusted so that  $Q_a^+ = Q_p$ ; this adjustment shall be based on the expected accuracies of these two measurements.

(e) Testing and evaluation procedures shall be in accordance with the provisions of this Code.

(f) The test overall heat transfer rate shall be computed from the test data, using Eq. (5.14).

(g) For adjustment of the test data to design conditions, Eq. (5.35) shall be used.

(h) For this example the air film is expected to be the major resistance; therefore, the test value of  $l/h_o$  shall be established by deducting the summation of the remaining resistances from the overall resistance.

(i) The process-side pressure drop predicted at design water circulation rate  $\Delta P^+$  shall be computed from

$$\Delta P^+ = (\Delta P^o) \left( \frac{W^+}{W^o} \right)^{1.80} \quad (\text{B.1})$$

Thermal performance capability will be expressed in terms of test capacity; that is, the actual quantity of process fluid the ACHE will handle at design conditions of fluid inlet and outlet temperatures, fluid inlet pressure, fluid composition, air inlet temperature, and fan power.

This will require an iterative or graphical solution, since test capacity, inside film resistance, and effective mean temperature difference are all unknown. The test capacity flow rate,  $W^+$ , will be assumed, and the heat load calculated independently from Eqs. (5.7) and (5.14). Values of  $W^+$  will be re-assumed and the computations repeated until the two heat

### B.4 DATA

Pertinent design and test data are:

	Design	Test
Water circulation rate, lbm/hr	285,000	277,000
Inlet water temperature, °F	168.0	160.0
Outlet water temperature, °F	149.0	141.2
Heat load, Btu/hr	5,415,000	5,207,600
Inlet water pressure, psig	60	57.2
Water pressure drop, psi	8.0	6.8
Air flow: total lbm/hr	578,526	540,692 <sup>Note 1</sup>
total SCFM	128,561	120,154 <sup>Note 1</sup>
total inlet ACFM	135,957	127,390 <sup>Note 1</sup>
exit ACFM per fan	72,755	68,459
Barometric pressure, in. Hg	29.92	29.73
Air temp., °F: Ambient DBT	94.0	91.2
Ambient WBT	75.0	76.7
Inlet DBT	95.0	92.2
Inlet WBT	76.0	77.3 <sup>Note 1</sup>
Exit DBT	134.0	133.5
Air density, lbm/ft <sup>3</sup> : Ambient	0.07105	0.07087
Inlet	0.07092	0.07074
Exit	0.06622	0.06578
Uncorrected MTD, °F	43.23	36.60
MTD correction factor °F	0.99	0.99
Corrected (effective) MTD, °F	42.80	36.24
Overall heat transfer coefficient: Btu/(hr-ft <sup>2</sup> -°F) <sup>Note 2</sup> : Service	104.91	119.15 <sup>Note 1</sup>
Drive-output power per fan, HP	10.20	11.40

#### NOTES:

- (1) calculated
- (2) based on external surface of prime tubes

loads are equal. The capability will then be computed from

$$\text{Percent Capability} = \frac{\text{Test Capacity}}{\text{Design Capacity}} \times 100$$

### B.5 PROCEDURE FOR CALCULATIONS

The following stepwise procedure is presented to clarify the order of the performance calculations:

(a) From the test data calculate heat loads from both process-side and air-side measurements. Compare the two values to determine whether or not the test is valid [See para. B.3(d) of this Example]. Adjust  $w^o$  to  $w^+$  so that  $Q_a^+ = Q_p$ .

(b) Compute test value of EMTD.

(c) Calculate test value of  $U_p^o$ .

(d) Calculate test values of all resistances, determining air film resistance by difference.

(e) Adjust test air flow rate and test air film resistance to design fan power and design air density.

(f) Assume a value of  $W^+$ , and compute  $Q$  from Eq. (5.7).

$$Q_p^+ = (W^+) (c_{p_p}) (T_1 - T_2) \quad (\text{B.2})$$

(g) Compute trial value of EMTD, based on assumed value of  $W^+$ , (process side) adjusted  $w^+$  (air side), and calculated  $t_2^+$ .

(h) Calculate adjusted value of inside film resistance. Unless test data differs markedly from design, Eq. (5.39) may be reduced to

$$\frac{R_i^+}{R_i^o} = \left( \frac{V_p^o}{V_p^+} \right)^{0.8} \quad (\text{B.3})$$

(i) Compute trial value of  $U_r^+$  from Eq. (5.35).

(j) Calculate  $Q^+$  from Eq. (5.14):  $Q_r^+ = U_r^+ A_r$  (EMTD).

(k) Repeat steps (f) through (j) until the values of  $Q^+$  from steps (f) and (j) are equal. Graphical or interpolation procedure may be used to expedite this trial-and-error solution of  $W^+$ .

(l) Calculate the capability of the ACHE, using the equation

$$\text{percent capability} = \frac{W^+}{W^*} \times 100 \quad (\text{B.4})$$

(m) Calculate the predicted process-side pressure drop from the equation

$$\Delta P_p^+ = \Delta P_p^o \left( \frac{W^+}{W^o} \right)^{1.80} \quad (\text{B.5})$$

## B.6 PERFORMANCE CALCULATIONS

Test heat load:

$$Q_p^o = W^o (H_{p_1}^o - H_{p_2}^o) \quad (\text{B.6})$$

$$= (277,000) (127.89 - 109.09) = 5,207,600 \text{ Btu/hr}$$

$$Q_p^o = w^o c_{p_a} \Delta t^o \quad (\text{B.7})$$

$$= (540,692) (0.2421) (133.5 - 92.2) = 5,406,456 \text{ Btu/hr}$$

Heat balance check:

$$\begin{aligned} \frac{Q_p^o - Q_p^+}{Q_p^o} \times 100 &= \frac{5,406,456 - 5,207,600}{5,207,600} \times 100 \\ &= 3.82\% \end{aligned}$$

Therefore, test heat balance is within permissible limits. At this point responsible parties to the test agreed that exit air temperature measurement was more accurate than air flow rate measurement; therefore, air temperatures for EMTD<sup>o</sup> calculation were not adjusted. Process-side heat load  $Q_p^o$  was used for the analysis, and measured air flow rate adjusted for heat balance:

$$\text{adjusted } w^o = 540,692 \times \frac{5,207,600}{5,406,456} = 520,805 \text{ lbm/hr}$$

Test EMTD:

$$T_1^o = 160.0^\circ\text{F}$$

$$T_2^o = 141.2^\circ\text{F}$$

$$t_1^o = 92.2^\circ\text{F}$$

$$t_2^o = 133.5^\circ\text{F}$$

$$\text{LMTD}^o = \frac{(141.2 - 92.2) - (160.0 - 133.5)}{\ln \frac{49.0}{26.5}}$$

$$= 36.605^\circ\text{F}$$

Correction factor:

$$P = \frac{t_2 - t_1}{T_1 - t_1} = \frac{133.5 - 92.2}{160.0 - 92.2} = 0.6091$$

$$R = \frac{T_1 - T_2}{t_2 - t_1} = \frac{160.0 - 141.2}{133.5 - 92.2} = 0.4552$$

$$F = 0.99$$

$$\text{EMTD}^o = 36.605 \times 0.99 = 36.24^\circ\text{F}$$

Unadjusted test  $U$ :

$$U_r^{\circ} = \frac{Q_p^{\circ}}{(A_r)(EMTD^{\circ})} = \frac{5,207,600}{(1206)(36.24)} = 119.15 \text{ Btu/hr-ft}^2\text{°F}$$

Test process fluid film resistance:

$$h_i^{\circ} = \left( \frac{0.023 k_p^{\circ}}{D_{p_i}} \right) \left( \frac{V_p^{\circ} D_{p_i} \rho_p^{\circ}}{\mu_p^{\circ}} \right)^{0.8}$$

$$\left( \frac{\mu_p^{\circ} c_{p_p}^{\circ}}{k_p^{\circ}} \right)^{0.33} \left( \frac{\mu_p^{\circ}}{\mu_{p_w}^{\circ}} \right)^{0.14}$$

$$k_p^{\circ} = 0.386 \frac{\text{Btu}}{\text{hr-ft}^2\text{-(°F/ft)}}$$

$$D_{p_i} = 0.902/12 = 0.07517 \text{ ft}$$

$$V_p^{\circ} = \frac{277,000}{(48)(\pi/4)(0.902/12)^2(61.18)} = 21,256 \text{ ft/hr}$$

$$\rho_p^{\circ} = 61.18 \text{ lbm/ft}^3$$

$$\mu_p^{\circ} = 0.455 \times 2.42 = 1.1011 \frac{\text{lbm}}{\text{hr-ft}}$$

$$c_{p_p}^{\circ} = 1.00 \text{ Btu/lbm °F}$$

$$\mu_{p_w}^{\circ} = 0.480 \times 2.42 = 1.1616 \frac{\text{lbm}}{\text{hr-ft}}$$

$$h_i^{\circ} = \left( \frac{0.023 \times 0.386}{0.07517} \right) \left( \frac{21,256 \times 0.07517 \times 61.18}{1.1011} \right)^{0.8}$$

$$\left( \frac{1.1011 \times 1.00}{0.386} \right)^{0.33} \left( \frac{1.1011}{1.1616} \right)^{0.14}$$

$$= (0.11811) (9091.7) (1.4133) (0.9925) = 1506.2 \text{ Btu/hr-ft}^2\text{°F}$$

$$\begin{aligned} \text{Inside film resistance} &= \frac{1}{h_i^{\circ}} \left( \frac{A_r}{A_{p_i}} \right) = \left( \frac{1}{1506.2} \right) \left( \frac{1.00}{0.902} \right) \\ &= 0.0007361 \text{ hr-ft}^2\text{°F/Btu} \end{aligned}$$

$$\begin{aligned} \text{Inside fouling resistance} &= (R_{f_i}) \left( \frac{A_r}{A_{p_i}} \right) \\ &= 0.0010000 \text{ hr-ft}^2\text{°F/Btu} \\ &\quad \text{[see para. B.3(c)]} \end{aligned}$$

$$\begin{aligned} \text{Outside fouling resistance} &= (R_{f_o}) \left( \frac{A_r}{A_{m_i}} \right) = 0 \\ &\quad \text{[see para. B.3(c)]} \end{aligned}$$

$$\text{Prime wall conduction resistance} = \frac{A_r \ln (r_{p_o}/r_{p_i})}{2 \pi L N k_{p_w}}$$

For the configuration used in this Example the preceding equation reduces to:

$$\text{Prime wall conduction resistance} = \frac{r_{p_o} \ln (r_{p_o}/r_{p_i})}{k_{p_w}}$$

$$= \frac{\frac{0.50}{12} \ln \frac{0.50}{0.451}}{64} = 0.0000672 \text{ hr-ft}^2\text{°F/Btu}$$

$$\begin{aligned} \text{Bond conduction resistance} \\ &= 0.0000100 \text{ hr-ft}^2\text{°F/Btu (from manufacturers' data)} \end{aligned}$$

$$\text{Fin root wall conduction resistance} = \frac{A_r \ln (r_{R_o}/r_{R_i})}{2 \pi L N k_R}$$

$$\text{Simplifying,} = \frac{r_{R_i} \ln (r_{R_o}/r_{R_i})}{k_R}$$

$$= \frac{\frac{0.50}{12} \ln \frac{0.58}{0.50}}{117} = 0.0000529 \text{ hr-ft}^2\text{°F/Btu}$$

Equivalent convection and conduction resistance of the fin =

$$\frac{1}{119.15} - 0.0007361 - 0.0010000 - 0.0000000 - 0.0000672 - 0.0000100 - 0.0000529 = 0.0065266 \text{ hr-ft}^2\text{-}^\circ\text{F/Btu}$$

Summary of *unadjusted* test resistances:

inside film .....	0.0007361
inside fouling .....	0.0010000
outside fouling.....	0.0000000
prime wall .....	0.0000672
bond .....	0.0000100
fin root wall.....	0.0000529
air film .....	<u>0.0065266</u>
	$\Sigma R = 0.0083928$

$$U_r^\circ = 1/\Sigma R = 1/0.0083928 = 119.15 \text{ Btu/hr-ft}^2\text{-}^\circ\text{F}$$

Adjusted test air flow rate:

$$w^+ = w^\circ \left( \frac{HP^*}{HP^\circ} \right)^{1/2.7} \left( \frac{\rho_a^*}{\rho_a^\circ} \right)^{2/3} = 520,805 \left( \frac{10.2}{11.4} \right)^{1/2.7} \left( \frac{0.06622}{0.06578} \right)^{2/3} = 502,012 \text{ lbm/hr}$$

NOTE: The value of  $w^\circ$  in this calculation is the test air flow rate adjusted for heat balance.

Adjusted test air film resistance:

$$R_a^+ = R_a^\circ \left( \frac{w^\circ}{w^+} \right)^{0.681} = 0.0065266 \left( \frac{520,805}{502,012} \right)^{0.681} = 0.006691 \text{ hr-ft}^2\text{-}^\circ\text{F/Btu}$$

Trial-and-error solution for  $W^+$ :

**Trial No. 1:** assume  $W^+ = 288,000 \text{ lbm/hr}$

$$Q^+ = (288,000) (1.00) (168.0 - 149.0) = 5,472,000 \text{ Btu/hr}$$

$$\Delta t_s = 5,472,000 / (502,012 \times 0.240) = 45.02^\circ\text{F}$$

$$t_2 = t_1 + \Delta t_s = 95.0 + 45.02 = 140.02^\circ\text{F}$$

$$\text{Trial EMTD} = \left[ \frac{(149.0 - 95.0) - (168.0 - 140.02)}{\ln \frac{54.0}{27.98}} \right] \times 0.99 = 39.18^\circ\text{F}$$

Adjusted inside film resistance:

$$R_i^+ = 0.0007361 \left( \frac{277,000}{288,000} \right)^{0.8} = 0.0007135$$

Summary of *adjusted* test resistances:

inside film .....	0.0007135
inside fouling .....	0.0010000
outside fouling.....	0.0000000
prime wall .....	0.0000672
bond .....	0.0000100
fin root wall.....	0.0000529
air film .....	<u>0.0066917</u>
	$\Sigma R = 0.0085353$

$$U_r^+ = 1/\Sigma R = 117.16$$

then,  $Q^+ = U_r^\circ + A_r (\text{EMTD})$

$$Q^+ = (117.16) (1206) (39.18) = 5,535,960 \text{ Btu/hr}$$

**Trial No. 2:** assume  $W^+ = 290,000 \text{ lbm/hr}$

$$Q^+ = (290,000) (1.00) (168.0 - 149.0) = 5,510,000 \text{ Btu/hr}$$



$$\Delta t_s = 5,510,000 / (502,012 \times 0.2421) = 45.33^\circ\text{F}$$

$$t_2 = 95.0 + 45.33 = 140.33^\circ\text{F}$$

$$\text{Trial EMTD} = \left[ \frac{(149.0 - 95.0) - (168.0 - 140.33)}{\ln \frac{54.00}{27.67}} \right]$$

$$\times 0.99 = 38.98^\circ\text{F}$$

$$\text{Adjusted } R_t^+ = 0.0007361 \left( \frac{277,000}{290,000} \right)^{0.8} = 0.0007096$$

$$\text{Adjusted } \Sigma R = 0.0085314$$

$$\text{Adjusted } U_t^+ = 117.21$$

$$Q^+ = (117.21) (1206) (38.98) = 5,510,231 \text{ Btu/hr}$$

**Trial No. 3:** assume  $W^+ = 290,022 \text{ lbm/hr}$

$$Q^+ = (290,022) (1.00) (19.0) = 5,510,513 \text{ Btu/hr}$$

$$\Delta t_s = 5,510,513 / (502,012 \times 0.2421) = 45.34^\circ\text{F}$$

$$t_2 = 95.0 + 45.33 = 140.34^\circ\text{F}$$

$$\text{EMTD} = 38.98^\circ\text{F}$$

$$\text{Adjusted } R_t^+ = 0.0007361 \left( \frac{277,000}{290,022} \right)^{0.8} = 0.0007095$$

$$\text{Adjusted } \Sigma R = 0.0085313$$

$$\text{Adjusted } U_t^+ = 117.22$$

$$Q^+ = (117.22) (1206) (38.98) = 5,510,498 \text{ Btu/hr}$$

By interpolation,  $W^+ = 290,022 \text{ lbm/hr}$

$$\begin{aligned} \text{Percent Capability} &= \frac{W^+}{W^*} \times 100 \\ &= \frac{290,022}{285,000} \times 100 = 101.76\% \end{aligned}$$

Process-side pressure drop:

$$\Delta P_p^+ = \Delta P_p^0 \left( \frac{W^+}{W^0} \right)^{1.8} = 6.8 \left( \frac{285,000}{277,000} \right)^{1.8} = 7.16 \text{ psi}$$

Since the allowable pressure drop (as stated in the inquiry) is 8.0 psi, the unit passed the pressure drop criterion.

## APPENDIX C – EXAMPLE UNCERTAINTY ANALYSIS

This Appendix provides an example uncertainty analysis for an Air Cooled Heat Exchanger (ACHE), using the methodology described in ASME PTC 19.1-1985. The example is for a post-test uncertainty analysis, using the design and test values for the engine jacket-water cooler example described in Appendix B.

### C.1 SUMMARY OF ANALYSIS APPROACH

The example uses the following step-wise approach, as prescribed in para. 4.2 of PTC 19.1:

(a) *Define Measurement Process.* The equations used in computing the test results are listed. From these equations, the independent measurement parameters are identified. These equations also provide the basis for developing the sensitivity factors for each parameter. The sensitivity factors are the functional relationships between each independent measurement parameter and the test result.

(b) *Calculate Bias and Precision Error Estimates.* The bias and precision error estimates are determined for each independent parameter. Typical values for each bias and precision error estimate are provided in this example. The analysis procedure for developing these values is not demonstrated in this example, but is addressed in great detail in PTC 19.1.

(c) *Propagate the Bias and Precision Errors.* Using the sensitivity factors and the bias and precision values for each independent parameter, the bias and precision errors are propagated separately.

(d) *Calculate Uncertainty.* The bias and precision errors are combined into an overall uncertainty value.

### C.2 DEFINITION OF LETTER SYMBOLS

Special letter symbols are used in this Appendix which do not appear elsewhere in the Code. The definitions for these symbols are:

$B_{ij}$  = the upper limit of the bias error for parameter  $j$

$S_{ij}$  = the precision index for parameter  $j$

$t_{\nu,95\%}$  = the Student-t statistic, determined from tabular data for a degrees of freedom,  $\nu$ , and a 95 percent coverage

$Un_{r,RSS}$  = the overall uncertainty of result,  $r$ , for a 95 percent coverage

$\nu_j$  = the degree of freedom for parameter  $j$ , used in evaluating the precision error

$\theta_j$  = sensitivity factor which functionally relates a change in an independent parameter  $j$  to the change in the result

### C.3 DEFINE MEASUREMENT PROCESS

There are two results calculated for the test example in Appendix B – *Capability* and *Process-Side Pressure Drop*. The development of sensitivity factors for each of these results will be illustrated.

**C.3.1 Capability.** The equations used to compute *capability* in Appendix B are repeated herein.

Recalling that the process-side heat load,  $Q_p^\circ$ , was used for the analysis, the following are the calculations for *capability*:

$$Q_p^\circ = W^\circ \times c_{pp}^\circ (T_1^\circ - T_2^\circ) \quad (C.1)$$

$$\text{EMTD}^\circ = 0.99 \times \frac{(T_2^\circ - t_1^\circ) - (T_1^\circ - t_2^\circ)}{\ln \left( \frac{T_2^\circ - t_1^\circ}{T_1^\circ - t_2^\circ} \right)} \quad (\text{C.2})$$

NOTE: A constant value of 0.99 is used for the Temperature Correction Factor,  $F$ . Referring to Fig. 5.7 for the test conditions of the Temperature Difference Ratio,  $R$ , and the Thermal Effectiveness,  $P$ , the value of  $F$  is nearly constant at 0.99 over a wide range of  $P$  and  $R$  values.

$$U_r^\circ = \frac{Q_p^\circ}{A_r \times \text{EMTD}^\circ} \quad (\text{C.3})$$

$$R_s^\circ = \frac{1}{U_r^\circ} - 0.0007361 - 0.0010000 - 0 \\ - 0.0000672 - 0.0000100 - 0.0000529$$

$$R_a^\circ = \frac{1}{U_r^\circ} - 0.0018662 \quad (\text{C.4})$$

NOTE: The other calculated resistance values, (0.0018662 = the sum of the resistances of the inside film, inside fouling, prime wall, etc.) are taken as constants because of the negligible changes in these values for the expected magnitudes of the measurement errors.

$$w^+ = w^\circ \left( \frac{H_p^*}{H_p^\circ} \right)^{1/2.7} \left( \frac{\rho^*}{\rho^\circ} \right)^{2/3} \quad (\text{C.5})$$

$$R_a^+ = R_a^\circ \left( \frac{W^\circ}{W^*} \right)^{0.681} \quad (\text{C.6})$$

$$Q_p^+ = W^+ \times c_{p_p}^* (T_1^* - T_2^*) \quad (\text{C.7})$$

$$\Delta t_a = \frac{Q_p^+}{W^+ c_{p_a}^*} \quad (\text{C.8})$$

$$t_2^+ = t_1^+ + \Delta t_a \quad (\text{C.9})$$

$$\text{EMTD}^+ = 0.99 \times \frac{(T_2^+ - t_1^+) - (T_1^+ - t_2^+)}{\ln \left( \frac{T_2^+ - t_1^+}{T_1^+ - t_2^+} \right)} \quad (\text{C.10})$$

$$R_p^+ = R_p^\circ \left( \frac{W^\circ}{W^+} \right)^{0.8} \quad (\text{C.11})$$

$$R_r = \text{Inside Film} + \text{Inside Fouling} + \text{Outside Fouling} \\ + \text{Prime Wall} + \text{Bond} + \text{Fin Root Wall} + \text{Air Film}$$

From Appendix B

$$R_r = R_s^+ + 0.0010 + 0.0000 + 0.0000672 \\ + 0.00001 + 0.0000529 + R_a^+$$

$$R_r + R_a^+ + R_i^+ + 0.0011301$$

$$U_r^+ = \frac{1}{R_s^+ + R_p^+ + 0.0011301} \quad (\text{C.12})$$

$$W^+ = \frac{Q_p^+}{c_{p_p}^* (T_1^* - T_2^*)} \quad (\text{C.13})$$

$$\text{CAPABILITY (\%)} = \left( \frac{W^+}{W^*} \right) \times 100 \quad (\text{C.14})$$

The next step is to identify the independent parameters which appear in the preceding equations, and then to develop a set of equations which functionally relate the independent parameters to the Capability (i.e., determine the sensitivity factors). The first part of this task is accomplished by simply listing all the parameters which appear in the equations, and eliminating all constants and all calculated parameters. All design values are considered constants for the purpose of the uncertainty analysis.

In reviewing the remaining parameters, it is necessary to ascertain if all of these parameters are, in fact, independent. To do this, it is necessary to review the calculations and corrections, if any, that were used in determining these values. In this case, the air flow rate,  $w^\circ$ , is found not to be an independent parameter. The air flow rate was determined by a velocity traverse at the discharge of each of the fans; however, by agreement, the mass flow rate of the air was based on a heat balance calculation for use in computing the test results. The equation for this computation was

$$w^\circ = W^\circ \frac{c_{p_p}^\circ (T_1^\circ - T_2^\circ)}{c_{p_a}^\circ (t^\circ - t_1^\circ)} \quad (\text{C.15})$$

The final list of independent variables then becomes:

$$T_1, T_2, W^o, WBT_1, t_1, t_2, hp^o, \text{ and } B^o.$$

As described in para. 2.7 of PTC 19.1, the sensitivity factor can be developed in either of two ways:

(a) When there are known mathematical relationships between the result and the independent parameter, the sensitivity factors can be computed analytically by partial differentiation of the equations.

(b) When no mathematical relationship is available or when differentiation is difficult, the sensitivity factors can be determined numerically by taking finite increments of each of the parameters and determining the effect of the incremental change on the result by using the data reduction calculation procedure.

For the Capability calculations, mathematical relationships are established, as demonstrated by the listed equations; however, there is no closed solution for these equations. The result must be determined by an iteration scheme between Eqs. (C.7) and (C.13). As a result, it is more practical and convenient to use a numerical solution approach in this case (assuming there is access to a computer).

The numerical development of the sensitivity factors for each of the independent parameters are provided in Tables C.1a and C.1b. For each independent parameter, positive and negative increments are added to the test values, with the incremental values being approximately equal to the expected precision and bias error values. Capability is determined stepwise for each incremental change. The sensitivity factor for each parameter is calculated as the change in Capability divided by the positive or negative incremental value. Positive and negative incremental values are used to determine the degree of non-linearity in the sensitivity factor around the test value. The Table results show the final solution for each parameter.

**C.3.2 Process-Side Pressure Drop.** The equation for the calculation of the process-side pressure drop is

$$\Delta P_p^+ = \Delta P_p^o \left( \frac{W^*}{W^o} \right)^{1.8} \quad (C.16)$$

In this case, there is a convenient mathematical relationship between the result,  $\Delta P_p^+$ , and the independent parameters,  $\Delta P_p^o$  and  $W^o$ . The absolute (dimensional) sensitivity factors,  $\theta_j$ , are determined by partial differentiation of Eq. (C.16) by

$$\theta_{\Delta P_p^o} = \frac{\delta \Delta P_p^+}{\delta \Delta P_p^o} = \left( \frac{W^*}{W^o} \right)^{1.8} = \frac{\Delta P_p^+}{\Delta P_p^o}$$

$$\theta_{W^o} = \frac{\delta \Delta P_p^+}{\delta W^o} = -1.8 \frac{\Delta P_p^o}{W^o} \left( \frac{W^*}{W^o} \right)^{1.8} = -1.8 \frac{\Delta P_p^+}{W^o}$$

Likewise, the relative (dimensionless) sensitivity factors,  $\theta'_{\Delta P_p^o}$  and  $\theta'_{W^o}$ , are determined by

$$\theta'_{\Delta P_p^o} = \frac{\delta \Delta P_p^+ / \Delta P_p^+}{\delta \Delta P_p^o / \Delta P_p^o} = 1$$

$$\theta'_{W^o} = \frac{\delta \Delta P_p^+ / \Delta P_p^+}{\delta W^o / W^o} = -1.8$$

#### C.4 DETERMINE THE BIAS AND PRECISION ERRORS

Tables C.2 and C.3 provide listings of the bias errors, the precision error estimates, and the degrees of freedom associated with each independent parameter used in computing the capability and the process-side pressure drop. As described previously, PTC 19.1 provides detailed instructions on the determination of the error terms. The values provided in Tables C.2 and C.3 are values which could typically be achieved using the procedures and methods described in this Code. The uncertainty values and the degrees of freedom associated with the precision indices are based on the assumption that a computer-based data acquisition system, with system accuracies in accordance with Section 4, was used to acquire the temperature data and the measurement of process flow rate. The other data — air flow rate, barometric pressure, fan horsepower, and process-side pressure drop — were acquired manually using instrumentation of the accuracies specified in Section 4. The degrees of freedom, which are determined from the number of readings and the number of measurement points, are based on a typical one-hour test.

It should be emphasized that the values for precision and bias error for each of the independent parameters listed in Tables C.2 and C.3 are the result of propagating all the identifiable elemental error sources. These values are provided for example purposes only. The actual bias and precision error values are dependent on the particular ACHE tested, the number and type of instruments, the calibration procedures used, the length of the test, the constancy of the test conditions, and the ambient conditions at the time of the test.





**TABLE C.1b  
SENSITIVITY FACTORS FOR UNCERTAINTY ANALYSIS**

Independent Parameters	Design	Test	+ dT <sub>i</sub>	- dT <sub>i</sub>	+ dWBT <sub>i</sub>	- dWBT <sub>i</sub>	+ dt <sub>2</sub>	- dt <sub>2</sub>	+ dHp°	- dHp°
A <sub>r</sub> , ft <sup>2</sup>	1206	...	...	...	...	...	...	...	...	...
T <sub>1</sub> (°F)	168	160	160	160	160	160	160	160	160	160
T <sub>2</sub> (°F)	149	141.2	141.2	141.2	141.2	141.2	141.2	141.2	141.2	141.2
W° (lbm/hr)	285000	277000	277000	277000	277000	277000	277000	277000	277000	277000
t <sub>1</sub> (°F)	95	92.2	92.7	91.7	92.2	92.2	92.2	92.2	92.2	92.2
WBT <sub>i</sub> (°F)	76	77.3	77.3	77.3	77.8	76.8	77.3	77.3	77.3	77.3
t <sub>2</sub> (°F)	134	133.5	133.5	133.5	133.5	133.5	134	133	133.5	133.5
hp° (Bhp)	10.2	11.4	11.4	11.4	11.4	11.4	11.4	11.4	11.9	10.9
B° (in. Hg)	29.92	29.73	29.73	29.73	29.73	29.73	29.73	29.73	29.73	29.73
R <sub>i</sub>	NA	0.000736	0.000736	0.000736	0.000736	0.000736	0.000736	0.000736	0.000736	0.000736
cp <sub>a</sub>		0.24211	0.24208	0.24215	0.2422	0.24202	0.24211	0.24211	0.24211	0.24211
ρ <sub>air</sub> (lbm/ft <sup>3</sup> )	0.06622	0.06578	0.06579	0.06577	0.06576	0.06581	0.06573	0.06584	0.06578	0.06578
<b>Calculated Values</b>										
w° (Eq. 15)		520804.6	527252.3	514489.9	520611.1	520998.3	514574.9	527187.0	520804.6	520804.6
Q <sub>p</sub> ° (Eq. 1)		5207600	5207600	5207600	5207600	5207600	5207600	5207600	5207600	5207600
EMTD° (Eq. 2)		36.23862	36.03460	36.44203	36.23862	36.23862	35.93048	36.54464	36.23862	36.23862
U <sub>r</sub> ° (Eq. 3)		119.1567	119.8313	118.4916	119.1567	119.1567	120.1786	118.1589	119.1567	119.1567
R <sub>a</sub> ° (Eq. 4)		0.006526	0.006478	0.006573	0.006526	0.006526	0.006454	0.006596	0.006526	0.006526
w <sup>+</sup> (Eq. 5)		502012.3	508175.9	495975.7	501927.5	502046.4	496258.9	507855.7	494094.4	510421.1
R <sub>a</sub> <sup>+</sup> (Eq. 6)		0.006691	0.006643	0.006739	0.006690	0.006692	0.006616	0.006766	0.006764	0.006616
W <sup>+</sup> GUESS		290022.1	292551.8	287538.6	290066.8	289955.2	290085.7	289936.5	286536.7	293702.0
Q <sup>+</sup> (Eq. 7)		5510421	5558484	5463233.	5511270	5509148.	5511628	5508794.	5444198.	5580338
Δt <sub>a</sub> (Eq. 8)		45.33750	45.18386	45.48883	45.33530	45.34081	45.87318	44.80262	45.51046	45.15638
t <sub>2</sub> <sup>+</sup> (Eq. 9)		140.3375	140.1838	140.4888	140.3353	140.3408	140.8731	139.8026	140.5104	140.1563
EMTD <sup>+</sup> (Eq. 10)		38.98022	39.07640	38.88530	38.98161	38.97815	38.64335	39.31418	38.87172	39.09358
R <sub>i</sub> <sup>+</sup> (Eq. 11)		0.000709	0.000704	0.000714	0.000709	0.000709	0.000709	0.000709	0.000716	0.000702
U <sub>r</sub> <sup>+</sup> (Eq. 12)		117.2176	117.9490	116.4975	117.2315	117.1968	118.2654	116.1876	116.1322	118.3607
W (Eq. 13)		290022.	292551.8	287538.6	290066.8	289955.2	290085.7	289936.5	286536.7	293702.0
%Cap. (Eq. 14)		101.7621	102.6497	100.8907	101.7778	101.7386	101.7844	101.7321	100.5392	103.0533
dCap [Note (1)]			0.887597	-0.87142	0.015675	-0.02349	0.022291	-0.03004	-1.22294	1.291174
dCap/dX			1.775195	1.742840	0.031350	0.046999	0.044582	0.060088	-2.44589	-2.58234
dCap/dx)avg				1.759017 dCap/dT <sub>i</sub>		0.039175 dCap/dWBT <sub>i</sub>		0.052335 dCap/dt <sub>2</sub>		-2.51412 dCap/dHp°

NOTE:  
(1) dCap = (%Cap - %Cap at Test Measured Conditions)



**TABLE C.2**  
**ERROR ESTIMATE VALUES FOR CAPABILITY**

Parameter	Bias Limit (Bi)	Precision Index (Si)	Degrees of Freedom (v)	Sensitivity Factors (θ) [Note (1)]
T <sub>1</sub> <sup>o</sup>	0.05	0.006	59	4.6114
T <sub>2</sub> <sup>o</sup>	0.10	0.013	58	6.3521
W <sup>o</sup>	2.5	0.25	59	1.0229
t <sub>1</sub> <sup>o</sup>	0.25	0.63	58	1.7590
WBT <sub>1</sub> <sup>o</sup>	0.25	0.50	58	0.0392
t <sub>2</sub> <sup>o</sup>	0.3	0.47	56	0.0523
hp <sup>o</sup>	0.2	0.08	7	2.5141
B <sup>o</sup>	0.01	0.012	3	1.7629

NOTE:  
(1) Reported from Tables C.1a and C.1b.

**C.5 PROPAGATE THE PRECISION AND BIAS ERRORS**

**C.5.1 Capability.** The bias limit of the result,  $B_{i_{cap}}$ , is computed using the equation

$$B_{i_{cap}} = \left[ \sum_{j=1}^N (\theta_j B_j)^2 \right]^{1/2} \quad (C.17)$$

Evaluating Eq. (C.17) with the values in Table C.2,

$$\begin{aligned} Bi_{T_1} &: (4.6114 \times 0.05)^2 = 0.053163 \\ Bi_{T_2} &: (6.3521 \times 0.10)^2 = 0.403492 \\ Bi_W &: (1.0299 \times 2.5)^2 = 6.629338 \\ Bi_{t_1} &: (1.7590 \times 0.25)^2 = 0.193380 \\ Bi_{WBT_1} &: (0.0392 \times 0.25)^2 = 0.000096 \\ Bi_{t_2} &: (0.0523 \times 0.3)^2 = 0.000246 \\ Bi_{hp} &: (2.5141 \times 0.2)^2 = 0.252828 \\ Bi_B &: (1.7629 \times 0.01)^2 = \underline{0.000311} \\ \Sigma Bi^2 &= 7.532854 \\ B_{i_{cap}} &= 2.745 \end{aligned}$$

The precision index of the result,  $Si_{cap}$ , is computed using the equation

$$Si_{cap} = \left[ \sum_{j=1}^N (\theta_j S_j)^2 \right]^{1/2} \quad (C.18)$$

Evaluating Eq. (C.18) with the values in Table C.2,

$$\begin{aligned} Si_{T_1} &: (4.6114 \times 0.006)^2 = 0.000766 \\ Si_{T_2} &: (6.3521 \times 0.013)^2 = 0.006819 \\ Si_W &: (1.0299 \times 0.25)^2 = 0.066293 \\ Si_{t_1} &: (1.7590 \times 0.63)^2 = 1.228041 \\ Si_{WBT_1} &: (0.0392 \times 0.50)^2 = 0.000384 \\ Si_{t_2} &: (0.0523 \times 0.47)^2 = 0.000604 \\ Si_{hp} &: (2.5141 \times 0.08)^2 = 0.040452 \\ Si_B &: (1.7629 \times 0.012)^2 = \underline{0.000448} \\ \Sigma Si^2 &= 1.343807 \\ Si_{cap} &= 1.1592 \end{aligned}$$

Since not all the degrees of freedom given in Table C.2 are greater than 30, the degrees of freedom for the result,  $v_{cap}$ , are computed according to the Welch-Satterthwaite formulas, as

$$v_{cap} = \frac{\left[ \sum_{j=1}^N (\theta_j S_j)^2 \right]^2}{\sum_{j=1}^N \frac{(\theta_j S_j)^4}{v_j}} \quad (C.19)$$

Applying the values of Table C.2 to Eq. (C.19)

$$\left[ \sum_{j=1}^N (\theta_j S_j)^2 (\theta_j S_j)^2 \right] = 1.8058$$

**TABLE C.3  
ERROR ESTIMATE VALUES FOR CAPABILITY**

Parameter	Bias Limit ( $Bi$ )	Precision Index ( $Si$ )	Degrees of Freedom ( $\nu$ )	Sensitivity Factors ( $\theta$ )
$W^o$	2.5	1.7	59	1
$\Delta P_p^o$	0.05	0.063	11	1.8

$$\sum_{j=1}^N \frac{(\theta_j S_j)^4}{\nu_j} = 0.02631$$

$$\nu_{cap} = \frac{1.8058}{0.02631} = 69$$

$$Si'_{\Delta P_p^+} = \frac{Si_{\Delta P_p^+}}{\Delta P_p^+} = \left[ \sum_{j=1}^N (\theta_j Si_j)^2 \right]^{1/2} \quad (C.21)$$

Evaluating Eq. (C.21) with the values in Table C.3,

**C.5.2 Process-Side Pressure Drop.** The relative bias limit of the result,  $Bi_{\Delta P_p^+}$  is computed using the equation,

$$Bi'_{\Delta P_p^+} = \frac{Bi_{\Delta P_p^+}}{\Delta P_p^+} = \left[ \sum_{i=1}^M (\theta_i Bi'_i)^2 \right]^{1/2} \quad (C.20)$$

where

$$Bi'_i = \frac{Bi_i}{j}$$

Evaluating Eq. (C.20) with the values in Table C.3,

$$Bi'_{\Delta P_p^+} = \left[ \underbrace{(1 \times 0.025)^2}_{(Bi'_w)^o} + \underbrace{\left(1.8 \times \frac{0.05}{6.8}\right)^2}_{(Bi'_{\Delta P_p^o})^o} \right]^{1/2} = 0.0283$$

From Appendix B,

$$\Delta P_p^o = 6.8 \text{ psi}$$

$$\Delta P_p = 7.16 \text{ psi}$$

$$Bi'_{\Delta P_p^+} = 0.0283$$

or,  $Bi_{\Delta P_p^+} = Bi'_{\Delta P_p^+} \times \Delta P_p^+ = 0.0283 \times 7.16 = 0.202 \text{ psi}$

The relative precision index of the result,  $Si_{\Delta P_p^+}$  is computed using

$$Si'_{\Delta P_p^+} = \left[ \underbrace{(1 \times 0.017)^2}_{(Si'_w)^o} + \underbrace{\left(1.8 \times \frac{0.063}{6.8}\right)^2}_{(Si'_{\Delta P_p^o})^o} \right]^{1/2}$$

$$Si'_{\Delta P_p^+} = 0.0238$$

$$Si_{\Delta P_p^+} = 7.16 \times 0.0238 = 0.170 \text{ psi}$$

The degrees of freedom of the result,  $\nu_{\Delta P_p^+}$ , is determined using Eq. (C.19) and the values in Table C.3 as,

$$\nu_{\Delta P_p^+} = \frac{\left[ (1 \times 0.017)^2 + \left(1.8 \times \frac{0.063}{6.8}\right)^2 \right]^2}{\frac{(1 \times 0.017)^4}{59} + \frac{\left(1.8 \times \frac{0.063}{6.8}\right)^4}{11}} = 38$$

**C.6 OVERALL UNCERTAINTY VALUES**

The overall uncertainty in the result for a 95 per cent coverage,  $Un_{r,RSS}$  is defined by,

$$Un_{r,RSS} = [Bi^2 + (tSi)^2]^{1/2} \quad (C.22)$$

The overall uncertainties are evaluated accordingly,

$$U_{cap,RSS} = [2.745^2 + (2 \times 1.1592)^2]^{1/2} = 3.59 \text{ percent}$$

$$U_{\Delta P_p^+,RSS} = [0.202^2 + (2 \times 0.170)^2]^{1/2} = 0.395 \text{ psi}$$

**TABLE C.4**  
**TWO-TAILED STUDENT-*t* TABLE FOR THE 95 PERCENT CONFIDENCE LEVEL**

Degrees of Freedom	<i>t</i>	Degrees of Freedom	<i>t</i>
1	12.706	16	2.120
2	4.303	17	2.110
3	3.182	18	2.101
4	2.776	19	2.093
5	2.571	20	2.086
6	2.447	21	2.080
7	2.365	22	2.074
8	2.306	23	2.069
9	2.262	24	2.064
10	2.228	25	2.060
11	2.201	26	2.056
12	2.179	27	2.052
13	2.160	28	2.048
14	2.145	29	2.045
15	2.131	30 or more use	2.0

GENERAL NOTE: Table gives values of *t* such that from  $-t$  to  $+t$  the area included is 95%.

where the value of the Student-*t* statistic, *t*, is determined from tabular data for the degrees of freedom (70 for capability and 38 for  $\Delta P_p^+$ ), and for a coverage of 95 percent (see Table C.4), *t* is equal to 2.

The results of Appendix B example are stated as follows:

$$TEST\ CAPABILITY = 101.8\ \text{percent} \pm 3.6\ \text{percent}$$

and,

$$\Delta P_p^+ = 7.16\ \text{psi} \pm 0.41\ \text{psi}$$

As discussed previously, the Appendix B example indicates a contractual specification that the air flow rate, used in the calculations of the test capability, would be determined using a heat balance calculation as defined in Eq. (C.15). Presumably, such an agreement would be based on a preliminary uncertainty analysis. As a check of this approach, an uncertainty analysis was also conducted based on using the measured air flow rate (i.e., the air flow rate calculated from the exit air velocity traverses) in the calculation of the test capability. The results of this analysis yielded

$$TEST\ CAPABILITY = 103.4\ \text{percent} \pm 4.0\ \text{percent}$$

## APPENDIX D

# SPECIAL CONSIDERATIONS FOR COMPUTATION AND ADJUSTMENT OF RESULTS

### D.1 INTRODUCTORY COMMENT

The adjustment of tube-side heat transfer and pressure drop data taken during a test compared to the design conditions is complicated by the many different combinations of flow regime, heat transfer process and stream composition that can exist on the tube side. The common case of single phase turbulent flow is dealt with in paras. 5.9.2 and 5.9.3. But laminar flows and condensing applications require different correlations and particularly greater attention to the details of the problem, and this Appendix offers some guides for analyzing these problems. For some of cases encountered, particularly in the process industries, more complex, usually computer-based, procedures are required. Some of these cases are identified below and references to the pertinent literature are given.

### D.2 FLUID WITH NO PHASE CHANGE

**D.2.1 Pressure Drop.** Pressure drop due to friction for single phase flow inside tubes may be estimated from the Moody-Darcy friction factor chart (Ref. [8]), given here as Fig. D.1. The pressure drop due to friction,  $\Delta P_f$ , is related to the friction factor,  $f_M$ , by

$$\Delta P_f = \left( \frac{f_M \rho_p V_p^2 L}{2D_i g_c} \right) \left( \frac{\mu_{p,w}}{\mu_p} \right)^{0.14} \quad (D.1)$$

The abscissa of Fig. D.1 is the Reynolds number of the tube-side fluid:

$$Re_i = \frac{D_i \rho_p V_p}{\mu_p} \quad (D.2)$$

The region of discontinuity ( $Re_i$  from 2100 to about 7000) between the laminar and turbulent regimes is

highly unpredictable and is very strongly influenced by entrance disturbances and flow maldistribution.

In turbulent flow, it is necessary to take wall roughness into account. New tubes may be considered smooth, and a good representation of that curve over the Reynolds number range from 10,000 to 100,000 is credited to Blasius (Ref. [9]) and given here as Eq. (D.3):

$$f_M = \frac{0.316}{\left( \frac{D_i \rho_p V_p}{\mu_p} \right)^{1/4}} \quad (D.3)$$

Older tubes may be considerably roughened by corrosion or deposits and relative roughness up to  $\epsilon/D_i = 0.003$  may be encountered in practice.

For flows that would normally be laminar, various types of twisted tapes, springs and solid cores may be inserted into the tube in order to disturb the flow and increase the heat transfer rate. The devices are variously termed turbulators, retarders, or accelerators, and they inevitably increase the pressure drop also. There are no general correlations applicable to all geometries, and the manufacturer of a particular device must usually be relied upon to supply the pressure drop and heat transfer correlations.

An additional pressure drop is encountered at the entrance to the tube due to the increase in kinetic energy of the fluid and the frictional losses associated with the expansion from the vena contracta and the formation of the fully-developed velocity profile. A reasonable estimate of this loss is 1-1/2 to 2 velocity heads for each pass, based on the velocity in the tubes:

$$\Delta P_{ent} = n \left( \frac{\rho_p V_p^2}{2g_c} \right) \quad (D.4)$$

where  $n = 1.5$  to 2 and  $\Delta P_{ent}$  is entrance pressure drop.

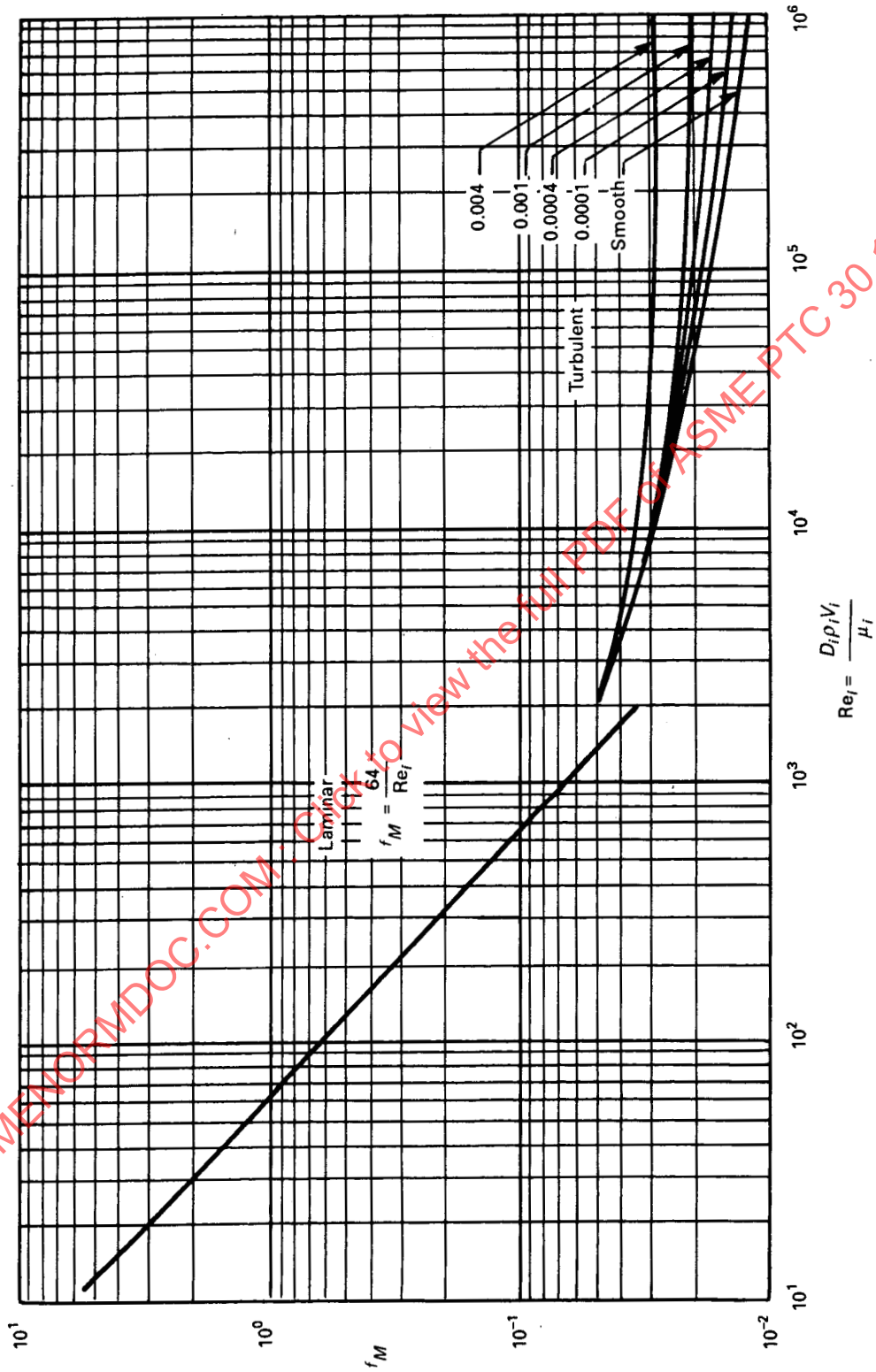

FIG. D.1 MOODY-DARCY FRICTION FACTOR CHART FOR FLOW THROUGH PLAIN TUBES



The total tube-side pressure drop is the sum of  $\Delta P_f$  and  $\Delta P_{ent}$ . Nozzle and header losses may need to be separately considered.

The properties used in these equations and those in the following paragraphs are usually evaluated at the arithmetic mean bulk temperature on the tube side, except for  $\mu_{p,w}$  which is evaluated at the inside wall temperature at the point where the fluid reaches its arithmetic mean bulk temperature.

**D.2.2 Heat Transfer.** The appropriate heat transfer correlation to use depends upon whether the flow is turbulent or laminar. For laminar flow ( $Re_i < 2100$ ), many different correlations and analytical treatments have been given in the literature. Reference [10] is the most comprehensive and up-to-date source. The Hausen equation (Ref. [11], [12]) is widely recommended in the literature to represent the major effects in laminar flow:

$$\frac{\bar{h}_{i,L} D_i}{k_p} =$$

$$\left[ 3.65 + \frac{0.0668 \left( \frac{D_i \rho_p V_p}{\mu_p} \right) \left( \frac{c_{p,p} \mu_p}{k_p} \right) \left( \frac{D_i}{L} \right)}{1 + 0.04 \left[ \left( \frac{D_i \rho_p V_p}{\mu_p} \right) \left( \frac{c_{p,p} \mu_p}{k_p} \right) \left( \frac{D_i}{L} \right) \right]^{2/3}} \right] \times \left( \frac{\mu_p}{\mu_{p,w}} \right)^{0.14} \quad (D.5)$$

where  $\bar{h}_{i,L}$  is the mean inside heat transfer coefficient for laminar flow in a tube of length  $L$ .

Examination of Eq. (D.5) reveals that for small  $L$ ,  $\bar{h}_i$  is proportional to  $L^{-1/3}$ , where  $L$  is the length of the tube. This is due to the development of an adverse temperature gradient as a result of the conductive heat transfer in the fluid. As mentioned above, various devices may be inserted into the tube in order to break up this gradient by disturbing the boundary layer or by forcing the flow to become turbulent. No general correlations are available for all such devices, and specific correlations for each type should be obtained from the vendor and their interpretation agreed upon prior to the test.

For fully developed turbulent flow ( $Re_i >$  approximately 7,000), there are several good correlations available. For general use, the Petukhov-Popov equation, Eq. (D.6), (Ref. [13]), is regarded as the most accurate but it is not in convenient form for ratioing changes in velocity, for example,

$$\frac{h_{i,t} D_i}{k_p} = \frac{\left( \frac{f_M}{8} \right) \left( \frac{D_i \rho_p V_p}{\mu_p} \right) \left( \frac{c_{p,p} \mu_p}{k_p} \right) \left( \frac{\mu_p}{\mu_{p,w}} \right)^{0.14}}{1.07 + 12.7 \left( \frac{f_M}{8} \right)^{1/2} \left[ \left( \frac{c_{p,p} \mu_p}{k_p} \right)^{2/3} + 1 \right]} \quad (D.6)$$

where the subscript  $t$  indicates *turbulent*.

The viscosity ratio has been added to the above equation here. The Moody-Darcy friction factor,  $f_M$ , in Eq. (D.6) can be calculated from Eq. (D.3).

The Sieder-Tate equation, Eq. (D.7), Ref. [4], is usually adequate for air cooler applications and is more convenient for adjustments of tube side conditions:

$$\frac{h_{i,t} D_i}{k_p} = 0.023 \left( \frac{D_i \rho_p V_p}{\mu_p} \right)^{0.8} \left( \frac{c_{p,p} \mu_p}{k_p} \right)^{1/3} \left( \frac{\mu_p}{\mu_{p,w}} \right)^{0.14} \quad (D.7)$$

For water, Figs. D.2a and D.2b taken from Kern (Ref. [14]), are very easy to use. Figures D.2a and D.2b may be represented by the following dimensional equation:

$$h_i = C (h_i)_{0.62} \quad (D.8a)$$

$$\text{where } (h_i)_{0.62} = 1.70 (100 + T) V_p^{0.8} \quad (D.8b)$$

$$\text{and } C = 0.911 - 0.429 \log_{10} D_i' \quad (D.8c)$$

where  $T$  is the mean water temperature in  $^{\circ}\text{F}$ ,  $V_p$  the tube inside water velocity in feet per second, and  $D_i'$  the inside tube diameter in inches.

The dimensions of  $h_i$  are then  $\text{Btu/hr-ft}^2\text{-}^{\circ}\text{F}$ , and  $h_i$  is based upon the inside area of the tube.



For transition flow ( $2100 < Re_i < 7,000$ ), no accurate predictions are possible because of the slowness with which fully-developed velocity and thermal profiles are achieved and because of the strong effect of the entrance flow geometry. An estimate can be made by linearly interpolating between the laminar flow heat transfer coefficient,  $\bar{h}_{i,L}$ , obtained from Eq. (D.5) and the turbulent flow result,  $h_{i,t}$ , obtained from Eq. (D.6) or (D.7), using the equation:

$$h_i = \bar{h}_{i,L} + (h_{i,t} - \bar{h}_{i,L}) \left( \frac{Re_i - 2100}{4900} \right)$$

for  $2100 < Re_i < 7000$  (D.9)

Any calculation in this range must be regarded as highly uncertain.

### D.3 SINGLE COMPONENT CONDENSATION

**D.3.1 General Comment.** The condensation of a single (pure) component can usually be considered to be carried out at nearly constant pressure and therefore at nearly constant temperature. However, the details of the condensation process are not fully understood, and the correlations correspondingly are not very precise. Coefficients for condensing steam or ammonia are so high (in the absence of non-condensable gas) that this uncertainty hardly matters. However, coefficients for other substances (such as propane or other light and medium hydrocarbons), while generally quite good, may be comparable to the air side when the area ratio is taken into account. The heat transfer correlations given below are accurate enough for most purposes. Prediction of pressure drop in two-phase flow is very uncertain; errors up to a factor of five are possible.

**D.3.2 Pressure Drop.** Pressure drop calculations in two phase flows in principle require the step by step integration of local conditions, coupled with the heat transfer rate to estimate the rate at which the vapor is being condensed. The total pressure effect is the algebraic sum of the frictional, momentum, and hydrostatic effects, of which the first is usually of the greatest concern. An important parameter is the quality of the flow, which is defined as the mass flow rate of the vapor phase only, divided by the total mass flow rate of both vapor and liquid phases. A saturated

vapor with no liquid present has a quality of 1.00, and a totally condensed stream at its boiling point or bubble point has a quality of zero.

Estimates can be made of the frictional loss using the work of Martinelli and Nelson (Ref. [15]). The frictional pressure drop through the tube for the condensing flow entering as a saturated vapor ( $x_1 = 1.0$ ), and exiting at a quality of  $x_2$  is found from

$$\Delta P_{p,TPF} = \bar{\phi}_{v,tt}^2 \Delta P_{p,v} \quad (D.10)$$

where *TPF* indicates *two-phase flow* and  $\Delta P_{p,v}$  is the pressure drop calculated from Eq. (D.1) assuming that the flow is all vapor and no condensation occurs.

The mean two-phase multiplying factor,  $\bar{\phi}_{v,tt}^2$  is read from Fig. D.3 as a function of the exit quality and the reduced pressure of the vapor,

$$P_r = \frac{P}{P_{cr}} \quad (D.11)$$

where  $P$  is the absolute pressure of the condensing vapor and  $P_{cr}$  is the absolute critical pressure of the vapor being condensed.  $P$  and  $P_{cr}$  must be in consistent units, usually psia.

The other two pressure effects that need to be considered in condensation are the momentum and hydrostatic contributions. Momentum effects arise from the deceleration of the vapor as it condenses; in principle, this results in a pressure recovery. However, this recovery is usually at least partially offset by increased friction losses in the liquid film. In design, it is usually conservative to neglect any pressure recovery that may occur. However, in analyzing the performance of a unit, this pressure recovery may explain, at least partly, why the pressure drop is less than that expected.

The hydrostatic pressure effect arises only for vertical or inclined tubes. The hydrostatic pressure effect results in an increase in the pressure at the lower end of the tube compared to a similar horizontal tube. Accounting for this effect requires detailed calculations of the local density of the two-phase mixture and is often (conservatively) omitted in condenser design.

### D.3.3 Heat Transfer Coefficients

**D.3.3.1 Horizontal Tubes.** At low condensing rates inside horizontal tubes, the condensate flows down the walls of the tube into a pool at the bottom of the tube, which then drains by gravity out of the end of